



2021

fleximatic®

Quality & Trust





Quality & Trust

CODE OF ETHICS

Fleximatic honors every agreement and commitment made with our Distributors by encouraging law-abiding operations, the compliance with tax regulations, and the fulfillment of all conditions, delivery times and services offered. We never do business directly with our Distributors' customers. We are convinced that, by upholding our values, we will be able to build a culture based on the transparency of our operations and institutional ethics for the benefit of all our clients and collaborators.

MISSION

To design, manufacture, commercialize and import high-end plumbing hardware and to import top quality tools, electrical fixtures, gardening accessories, and piping fittings. Also, to foster profitability and competitiveness for our commercial partners and to provide our staff with career growth opportunities.

VISION

To become the leading company in the plumbing hardware sector worldwide.

"Everything we do must bring value to the customer."

- ✓ We are a proud team of Mexican manufacturers and distributors of high-end plumbing hardware.
- ✓ Our products are made using 100% virgin raw materials and feature unique, leading-edge designs.
- ✓ World pioneers in the development of sink traps with flexible extensions.
- ✓ We have installed quality and trust in homes for over 35 years.
- ✓ Pioneers in creating products with the Zero Leakage technology that brings leaks directly to the drainage.



We hold more than 100 patents, utility models and industrial designs.

"When you care about water, you care about life."

www.fleximatic.com.mx

Fleximatic leading the way!

At Fleximatic, we want the best quality for our customers, that is why we use 100% virgin materials offering great advantages; one of them is acetal resin (POM raw material).

Why do we use acetal resin?



Acetal resin (POM raw material) is a plastic material listed among the so-called "auto lubricated". The homopolymer possesses a higher crystallinity, improving resistance to impact and providing greater rigidity and soundness; this makes it a good alternative to metal. Thanks to its limited thermal expansion and low water absorption, it will neither corrode nor rust, ensuring a longer service lifespan. It is resistant to chemicals and is unaffected by solvents and combustibles, among other substances. POM raw material is chemically resistant to alkalis, hydrocarbons, oils, grease, gasoline and most cleaning agents.

- ✓ Limited thermal expansion and low water absorption.
- ✓ Resistant to solvents and other chemicals.
- ✓ Will neither corrode nor rust.
- ✓ Resistant to high temperature.
- ✓ Metal-like resistance.



Find our acetal resin products on pages **22 and 34**

Code	Page	Code	Page	Code	Page	Code	Page	Code	Page	Code	Page
544	41	2347	18	2579	23	3337	9	4487	48	15-500	61
2028	42	2348	18	2586	43	3337A	9	4490	40	15-600	61
2145	39	2349	18	2587	42	3338	11	4502	48	16-100	62
2207	39	2351	19	2588	42	3345	20	4503	50	16-200	62
2209	34	2352	19	NEW 2590	34	3500	14	4504	50	16-300	62
2212	20	2353	19	NEW 2594	42	3500C	14	4505	51	16-400	62
NEW 2212A	38	2370	16	2597	40	3503	14	4506	51	16-500	62
2214	21	2390	29	2602	34	3503C	14	4530	48	16-600	62
2215	20	2392	30	2604	34	3603	14	4531	49	17-100	62
2217	9	2402	30	2608	36	3604	14	4532	49	17-200	62
2218	8	2401	27	2611	37	3635	14	4533	50	17-300	62
NEW 2218A	38	2404	30	2619	34	4131	54	4534	50	17-400	62
2219	8	2406	26	2626C	36	4132	54	4535	50	17-500	62
2220	21	2410	40	NEW 2627	38	4133	54	4536	50	17-600	62
2222I	22	2411	30	NEW 2629	38	4136	54	4537	50	18-100	62
2224	22	2412	30	2640	34	4137	54	4538	50	18-200	62
2225	9	2413	41	2646	39	4138	54	4556	54	18-300	62
2227	8	2415	28	2647	39	4139	54	4557	54	18-400	62
2232	22	2416	28	2648	39	4140	55	4558	54	18-500	62
2234	14	2416 N I	28	2649	39	4141	55	4559	54	18-600	62
2235	8	2418 I	48	2663	37	4142	55	4560	54	18-700	62
NEW 2235A	38	2420	40	2684	32	4150	55	4588	40	18-800	62
2236	8	2420 T	40	2691	40	4151	55	4601	53	19-100	62
2237	21	2420 V	40	2701	29	4152	55	4602	53	19-200	62
2238	21	2424	42	2706	29	4153	55	4611	53	19-300	62
2240	21	2426	41	2707	29	4154	55	4641	53	19-400	62
2241	21	2428	22	2708	29	4155	55	7001	54	19-500	62
2244	20	2429	22	NEW 2710	27	4156	55	7002	54	19-600	62
2246	21	2432	52	2715	26	NEW 4157	55	7006	54	20-100	62
2248	37	2434	52	2716	26	NEW 4160	55	7011	53	20-200	62
2249	37	2435	53	2720A	23	4161	55	7012	53	20-300	62
2250	33	2438	22	2723	26	4200	48	8360	54	20-400	62
2250C	32	2439	22	2722	26	NEW 4201	48	10-100	61	20-500	62
2251	13	2442	54	2724	26	NEW 4202	43	10-200	61	20-600	62
2253	32	2446	22	2724P	27	4401	43	10-210	61	21-100	62
2254	32	2447	22	2726	27	4402	48	10-220	61	21-200	62
2256	40	2448	41	2743	43	NEW 4406	48	10-230	61	21-300	62
2258	32	2449	30	2807	16	4407	43	10-300	61	21-400	62
2264C	32	2451	53	2808	16	NEW 4412	43	10-400	61	21-500	62
2265	20	2462	28	2810	16	4409	52	10-500	61	21-600	62
2268C	37	2463	28	2812	16	4415	51	10-600	61	22-100	62
2269C	36	2464	28	2919	8	4416	51	11-200	61	22-200	62
2270C	36	2471	24	2926	8	4417	51	11-300	61	22-300	62
2271	36	2471 C/F	24	2929	9	4418	51	11-400	61	22-400	62
2272C	36	2472	22	2931	10	4419	52	11-500	61	22-500	62
2277	39	2472 C	22	2932A	10	4422	52	11-600	61	22-600	62
2280	37	2474G	24	2934	14	4424	52	12-100	61	23-100	62
2284	16	2476	22	2935	8	4427	48	12-200	61	23-200	62
2288	13	2478	41	2936	8	4429	49	12-300	61	23-300	62
2289	21	2479	41	2938	10	4430	51	12-400	61	23-400	62
2291	13	2480	42	2939	9	4431	51	12-500	61	23-500	62
2294	13	2482	42	2940	10	4432	51	12-600	61	23-600	62
2297	16	2486	24	2941	10	4433	52	13-100	61	23-700	62
2299	21	2487	24	2942	11	4434	52	13-200	61	23-800	62
2300	21	2488	24	2944	19	4441	53	13-210	61	23-900	62
2301	21	2489	24	2945	19	4442	53	13-300	61	24-100	62
2302	21	NEW 2490	43	2949	11	4443	53	13-400	61	24-200	62
2307	16	2491	37	2988	13	4456	56	13-500	61	24-300	62
2311	20	2492	28	2990	13	4457	56	13-600	61	30-100	58
2312	20	2494	42	3204	45	4473	49	14-100	61	30-200	58
NEW 2313C	34	2498	21	3205	45	4474	49	14-200	61	30-300	58
2314C	34	2502 A	24	3207	45	4475	49	14-300	61	30-310	58
2315	34	2550	33	3209	45	4478	56	14-400	61	30-320	58
2325	18	2561	41	3210	45	4481	56	14-500	61	30-400	58
2326	19	2562	30	3212	45	4482	49	14-600	61	30-500	61
2335	13	2563	41	3218	46	4483	49	15-100	61	30-600	58
2338	18	2566	41	3219	46	4484	49	15-200	61	30-650	60
2339	18	2575	23	3220	46	4485	50	15-300	61	30-660	60
2344	18	2577	23	3336	9	4486	56	15-400	61	30-700	58

Code	Page	Code	Page
30-900	58	43-210	60
30-931	58	45-200	59
30-932	58	45-300	59
30-933	58	45-400	59
31-200	58	45-500	59
31-210	60	45-600	59
31-300	58	45-700	59
31-400	58	46-200	59
31-500	58	46-300	59
31-600	58	46-400	59
31-610	58	46-500	59
31-620	58	46-600	59
31-630	58	46-700	59
31-650	60	59-200	60
31-670	60	59-300	59
31-680	60	59-400	59
31-700	58	59-500	59
32-200	58	59-600	59
32-210	60	59-700	59
32-300	58	FLE-08	11
32-320	58	W4404	52
32-400	58	W2483	23
32-500	58		
32-600	58		
32-700	58		
33-200	58		
33-300	58		
33-400	58		
33-500	58		
33-600	58		
33-700	58		
36-200	58		
36-300	58		
36-332	59		
36-333	59		
36-334	59		
36-335	59		
36-400	58		
36-500	58		
36-600	58		
36-700	58		
37-200	59		
37-300	59		
37-400	59		
37-500	59		
37-600	59		
37-700	59		
39-200	59		
39-300	59		
39-400	59		
39-500	59		
39-600	59		
39-700	59		
40-320	59		
40-400	59		
40-410	59		
40-420	59		
40-430	59		
40-440	59		
40-500	59		
40-600	59		
40-700	59		
40-710	59		
40-720	59		
40-800	59		
40-810	59		
40-820	59		
40-830	59		
43-200	58		

	Page
Bathroom sink traps	7-11
Kitchen sink traps	12-14
P-traps	16
Traps Drains	17-19
Add-ons and spare parts	20-24
Flush valve kits	25-30
Floor drains	31-34
Side outlet drains	35-36
Minimalist line	37-38
Miscellaneous	39-43
Installation kits	45-46
Faucet	48-55
Innovance	56
Fittings	58-62
Promotional	63
Coming soon	64

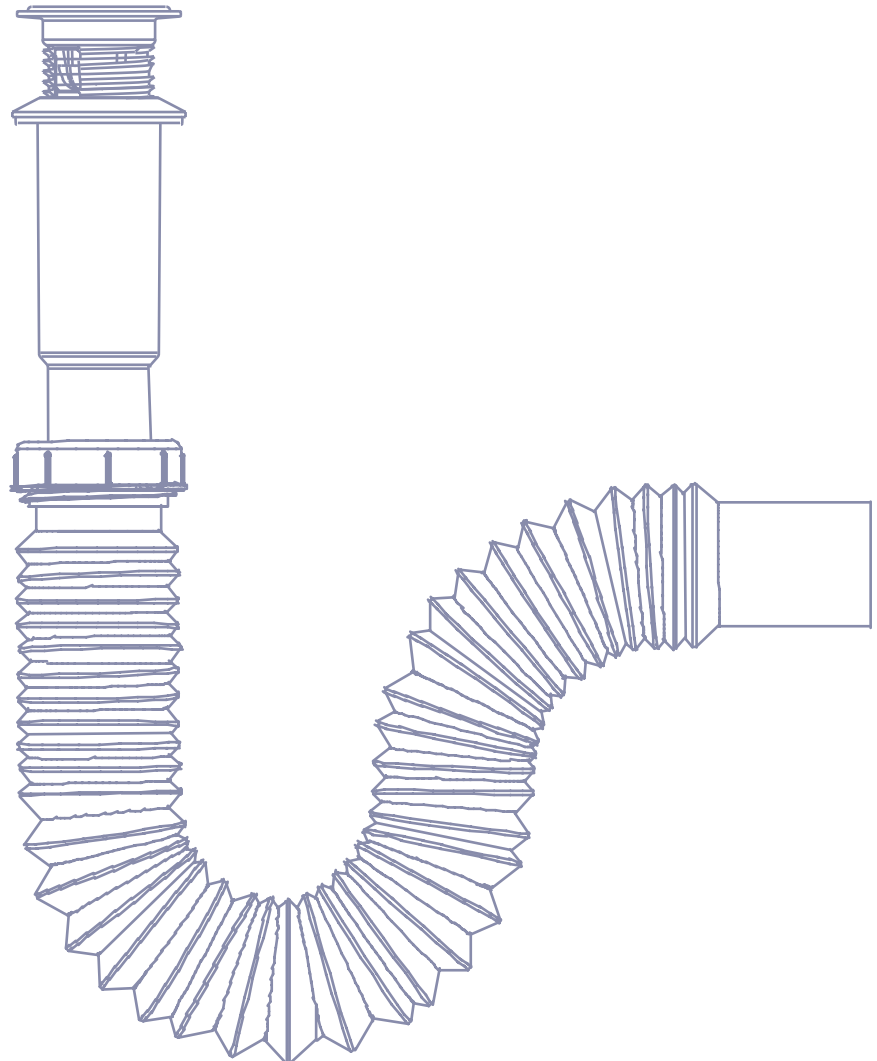



Quality & Trust

Backwater line



Code 2644
4" Backwater Valve



Code 2645
6" Backwater Valve



Code 2590
**Universal anti-odor
check valve**

Code 2550
**Zero-odor universal drain,
stainless steel beveled edge,
hygienic lid and hair stopper,
with check valve**



Code 2689CH
**Universal drain, grid with
stainless steel cover and classic
beveled edge with check valve**

- ✓ **Great water flow capacity**
- ✓ **Stops drain odor and bugs**
- ✓ **Prevents backwater flow**



Code 2260
**Zero-odor universal drain
with check valve**



800 08 FLEXI
(35394)



www.fleximatic.com.mx



Quality & Trust

SINK TRAPS

BATHROOM

Technical specifications:

Material: White polypropylene (raw material) and soft PVC (raw material).

Differentiating attributes:

- Flexible accordion (1 1/2" diameter), prevents any possibility of clogging and provides a larger water outlet.
- The use of virgin raw materials (not recycled or reworked) provides more strength, durability and, above all, flexibility.
- Tapered threads with perfect sealing to prevent both seizing and leaking at the same time.
- Zero odor.
- Extra large trap.
- Easy installation.

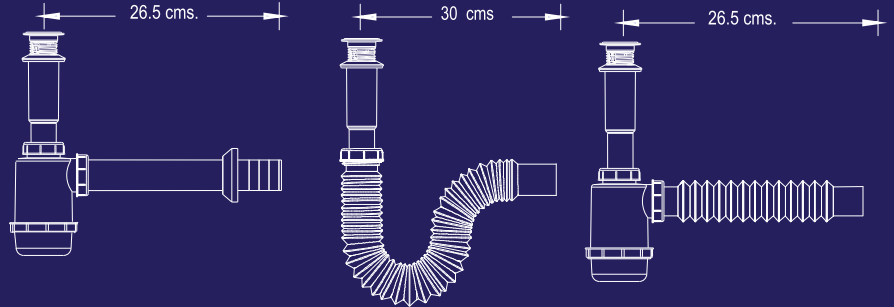

COVER



ZERO ODOR FROM BACTERIA



ZERO LEAKAGE
"THE NAME SAYS ALL"

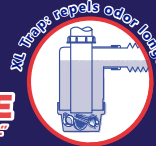

ZERO ODOR
"THE NAME SAYS ALL"



BOTTLE



EXTENSION

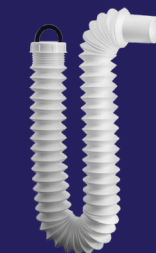



Code 2218
Plastic sieve



Code 2219
Stainless steel cover

Code 2218 | 30 PCS
Flexible trap

With small bottle and sieve
(0.82'/25 cm extension).

Code 2219 | 30 PCS
Flexible trap

With small bottle and stainless
steel cover (0.82'/25 cm extension).



Code 2919 | 25 PCS
Flexible trap

With small bottle and stainless
steel cover (1.8'/55 cm extension).



Code 2227 | 20 PCS
Flexible trap

With large bottle and stainless steel
cover (0.82'/25 cm extension).



Code 2926 | 20 PCS
Flexible trap

With large bottle and sieve
(1.8'/55 cm extension).



Code 2235
Plastic sieve



Code 2236
Stainless steel cover

Code 2235 | 25 PCS
Flexible trap

P-trap and sieve (1.8'/55 cm
extension).

Code 2236 | 25 PCS
Flexible trap

P-trap and stainless steel cover
(1.8'/55 cm extension).



Code 2935
Plastic sieve



Code 2936
Stainless steel cover

Code 2935 | 25 PCS
Flexible trap

Stainless steel cover (2.6'/80
cm extension).

Code 2936 | 25 PCS
Flexible trap

P-trap and stainless steel cover
(2.6'/80 cm extension).



Code 3336 | 25 PCS
Flexible trap

P-trap (chrome) with stainless steel cover (2.6'/80 cm extension).

Code 3337 | 25 PCS
Flexible trap

P-trap (chrome) with stainless steel cover (1.8'/55 cm extension).



Code 3337A | 25 PCS
Flexible trap

P-trap (chrome) with stainless steel cover (1.8'/55 cm extension). W/o overflow for vessel sink.



Code 2217 | 25 PCS
Rigid trap

With small bottle and stainless steel cover.



Code 2225 | 20 PCS
Rigid trap

With large bottle and stainless steel cover.



Code 2939 | 30 PCS
Kompakt trap

In chrome with stainless steel cover (1.8'/55 cm extension).

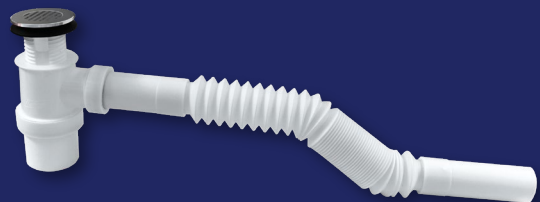

Code 2929 | 30 PCS
Kompakt trap

With stainless steel cover (1.8'/55 cm extension).

P-TRAP

Featuring
DUAL SEAL SYSTEM

Gasket seal

Inner seal
around walls

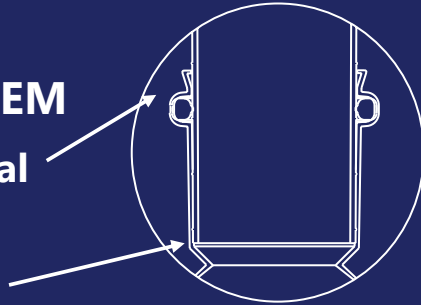

- ✓ Easy installation.
- ✓ Fixes misalignment.
- ✓ 100% raw material.
- ✓ Flexible pipe.
- ✓ Prevents drain odor.
- ✓ Easy cleaning and maintenance.

1 1/4" TRAP FAMILY



5
YEAR
WARRANTY

Code 2931 35 PCS

Practical trap

Flexible P-trap for bathroom sink (2.6'/80 cm extension).
1 1/4" drainage outlet.



5
YEAR
WARRANTY

Code 2932A 35 PCS

Practical trap

Flexible P-trap with stainless steel cover for bathroom sink (1.8'/55 cm extension).
1 1/4" drainage outlet.



5
YEAR
WARRANTY

Code 2938 35 PCS

Flexible trap

Flexible P-trap, grid without cover (1.8'/55 cm extension) for vessel sink. 1 1/4" drainage outlet.



5
YEAR
WARRANTY

Code 2940 50 PCS

P-trap

Flexible (1.8'/55 cm) for bathroom sink.
1 1/4" drainage outlet.



5
YEAR
WARRANTY

Code 2941 50 PCS

P-trap

Flexible (2.6'/80 cm) for bathroom sink.
1 1/4" drainage outlet.



Code 2949 35 PCS

Practical trap

Flexible P-trap for kitchen sink
(1.8'/55 cm extension).
1 1/2" drainage outlet.

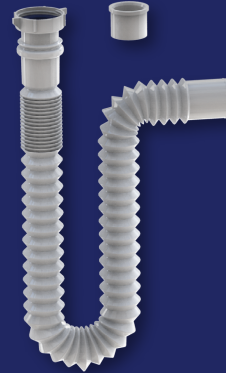

Code 2942 50 PCS

Trap extension

Universal flexible trap (2.6'/80 cm)
for kitchen/bathroom sink.
1 1/2" drainage outlet.



Code 3338 35 PCS

Practical trap

Flexible bathroom sink trap (chrome)
with pop-up button.
1 1/2" drainage outlet.

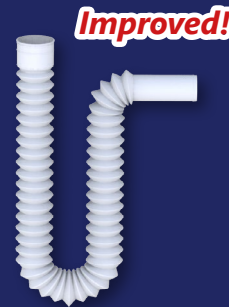

Improved!



Code FLE-08 35 PCS

Flexitrap

Universal, 2.6'/80 cm with 1/2"
and 1 1/4" adapter.
For bathroom/kitchen sink.

Follow us!



Follow us on social media for updates
on new products, events,
tutorials and more!



/FleximaticOficial



/FleximaticOficial



/Fleximatic

www.fleximatic.com.mx



Quality & Trust

SINK TRAPS

KITCHEN

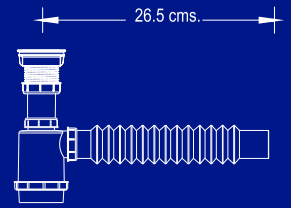
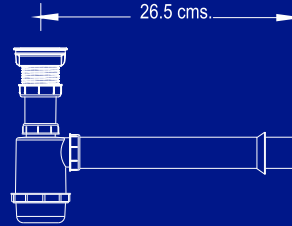
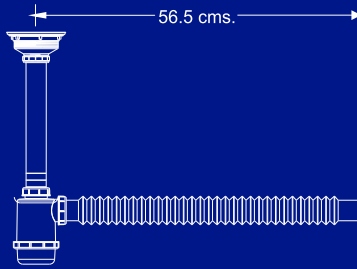
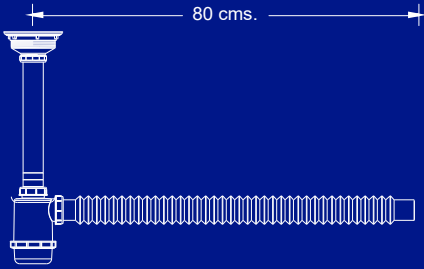

Technical specifications

Material: White polypropylene (raw material) and soft PVC (raw material)

Differentiating attributes:

- Flexible accordion (1 1/2" diameter), prevents any possibility of clogging and provides a larger water outlet.
- The use of virgin raw materials (not recycled or reworked) provides more strength, durability and, above all, flexibility.
- Tapered threads with perfect sealing to prevent both seizing and leaking at the same time.
- Zero odor.
- Extra large trap.
- Easy installation.



COVER



STAINLESS STEEL COVER



WITH PLASTIC STRAINER



PRACTIKAL BASKET STRAINER



COMBINED BASKET STRAINER



STAINLESS STEEL BASKET STRAINER



BOTTLE

EXTENSION



LARGE BOTTLE



SMALL BOTTLE

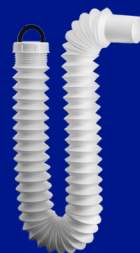

JUMBO 2.6'/80 CM



XL 1.8'/55 CM



9.8"/25 CM

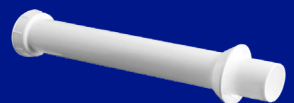

RIGID



Code 2288 | 25 PCS

Flexible trap

Small bottle and grid with stainless steel cover (9.8"/25 cm extension).



Code 2988 | 25 PCS

Flexible trap

Small bottle and grid with stainless steel cover (1.8"/55 cm extension).



Code 2291 | 20 PCS

Flexible trap

Large bottle and plastic strainer without cover (9.8"/25 cm extension).



Code 2990 | 20 PCS

Flexible trap

Large bottle and grid with stainless steel cover (1.8"/55 cm extension).

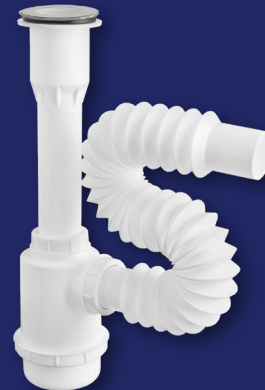

Code 2294 | 15 PCS

Flexible trap

Large bottle and grid with stainless steel cover (1.8"/55 cm extension).



Code 2251 | 20 PCS

Rigid trap

Large bottle and plastic strainer without stainless steel cover.



Code 2335 | 12 PCS

Flexible trap

Large bottle and stainless steel sink strainer (1.8"/55 cm extension).

KITCHEN SINK TRAPS

www.fleximatic.com.mx

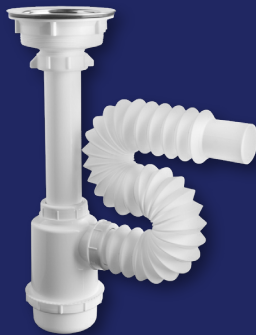

Code 3500 12 PCS

Flexible trap

Large bottle and combined sink strainer (1.8'/55 cm extension).



Code 3500C 12 PCS

Flexible trap

Large bottle and Practikal sink strainer (1.8'/55 cm extension).



Code 3635 12 PCS

Flexible trap

Large bottle and stainless steel sink strainer (2.6'/80 cm extension).



Code 3603 20 PCS

Flexible trap

P-trap w/ combined basket strainer, 4"/10 cm flanged tailpiece and 2.6'/80 cm extension.



Code 3604 25 PCS

Flexible trap

P-trap w/ stainless steel sink strainer, 4"/10 cm flanged tailpiece and 2.6'/80 cm extension.



Code 2234 25 PCS

Flexible trap

P-trap and grid w/ stainless steel cover (1.8'/55 cm extension).



Code 3503 30 PCS

Flexible trap

P-trap w/ combined sink strainer, 4"/10 cm flanged tailpiece and 1.8'/55 cm extension.



Code 3503C 30 PCS

Flexible trap

P-trap w/ Practikal basket strainer (1.8'/55 cm extension).



Code 2934 25 PCS

Flexible trap

P-trap and grid w/ stainless steel cover (2.6'/80 cm extension).



The Push system by Fleximatic!

Our floor drain family grows with the pop-up drain that you can open to let water through and close accordingly to prevent wastewater odor from entering.

Our pop-up floor drains feature an ABS raw material plastic body, a 0.4" thick stainless steel cover with no sharp edges, a rust-proof brass pop-up mechanism with a lifespan of up to 50 thousand uses, an acetal resin core and a silicone gasket. Silicone provides greater flexibility, functionality and durability, guaranteeing perfect sealing to prevent wastewater odor from entering.

- ✓ ABS raw material body.
- ✓ Brass pop-up mechanism.
- ✓ Up to 50,000 uses guaranteed.
- ✓ Silicone gasket.

Find our Push products
on page 37

RUST-PROOF!

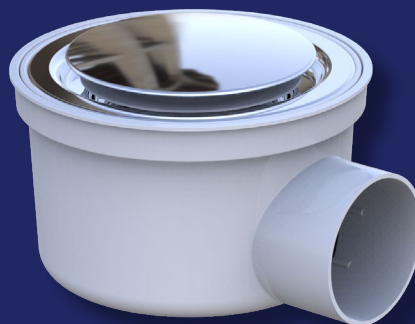



Code 2297 25 PCS

Trap

Large bottle (0.82'/25 cm extension).

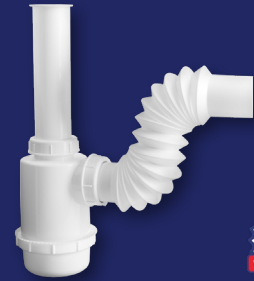

Code 2284 18 PCS

Trap

Large bottle with 0.82'/25 cm flanged tailpiece (1.8'/55 cm extension).

SOFT PVC P-TRAPS

Technical information

Material: Soft PVC.

- Universal compatibility thanks to its joint gasket for kitchen sink or adapter gasket for bathroom sink.
- Only product with a threaded adapter on the lower end for fittings to the sink tailpiece, avoiding the use of clamps.
- Slip nuts with tapered threads to prevent seizing.
- Perfect sealing to prevent leaks.

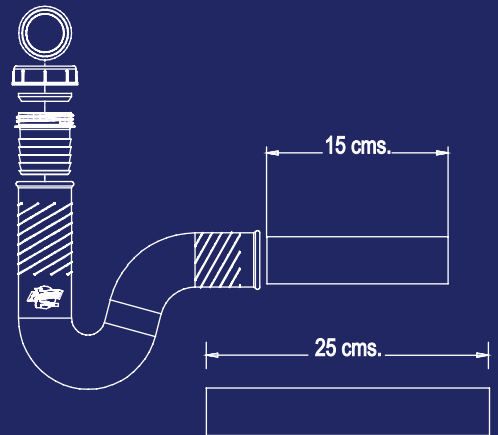

Code 2370 35 PCS

J-trap

For bathroom or kitchen sink.



Code 2810 20 PCS

Soft PVC P-trap

Universal with 5.9"/15 cm arm, threaded adapter and slip nut. For bathroom or kitchen sink.



Code 2808 30 PCS

Soft PVC P-trap

Without arm, with threaded adapter and slip nut. For bathroom or kitchen sink.

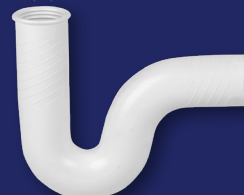

Code 2807 30 PCS

Soft PVC P-trap

Without arm, without threaded adapter. For bathroom or kitchen sink.



Code 2812 20 PCS

Soft PVC P-trap assembly

Without cover. For bathroom sink.



Quality & Trust

DRAINS

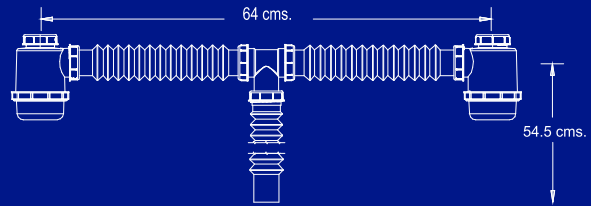
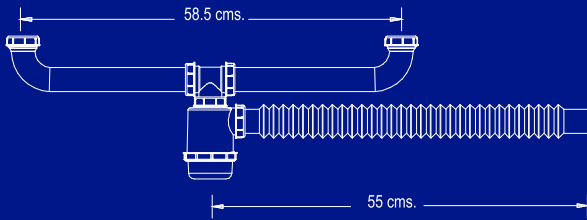

Technical specifications

Material: White polypropylene (raw material) and soft PVC (raw material).

Differentiating attributes:

- Flexible accordion (1 1/2" diameter), prevents any possibility of clogging and provides a larger water outlet.
- The use of virgin raw materials (not recycled or reworked) provides more strength, durability and, above all, flexibility.
- Tapered threads with perfect sealing to prevent both seizing and leaking at the same time.
- "Zero Odor" extra large trap.

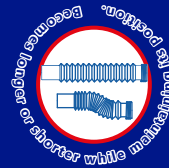

COVER



COMBINED BASKET STRAINER



PRACTIKAL BASKET STRAINER



STAINLESS STEEL BASKET STRAINER

BOTTLE



LARGE BOTTLE



WITHOUT BOTTLE

EXTENSION



XL 1.8"/55 CM



9.8"/25 CM

BODY

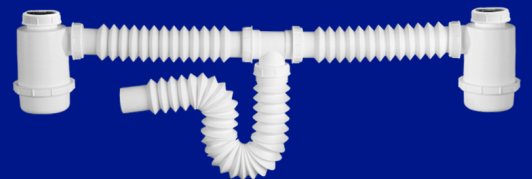

FLEXIBLE



RIGID



Code 2348 15 PCS

Drain

Rigid standard (American) with large adjustable tee fitting.



Code 2349 15 PCS

Drain

Rigid standard (American) with two 3.9"/10 cm flanged tailpieces and large tee fitting.



Code 2347 10 PCS

Drain

Rigid standard (American) with large bottle trap and large tee fitting (1.8'/55 cm extension).

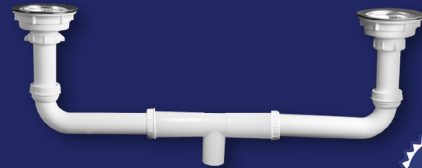

Code 2344 12 PCS

Drain

Rigid standard (American) with two combined sink strainers, two 3.9"/10 cm flanged tailpieces and large adjustable tee fitting.

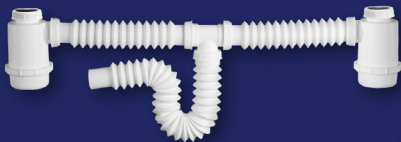

Code 2325 10 PCS

Drain

Double large bottle trap drain (1.8'/55 cm extension).

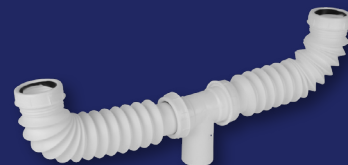

Code 2338 30 PCS

Drain

With 9.8"/25 cm flexible extension.



Code 2339 25 PCS

Drain

With 1.8'/55 cm flexible extension.

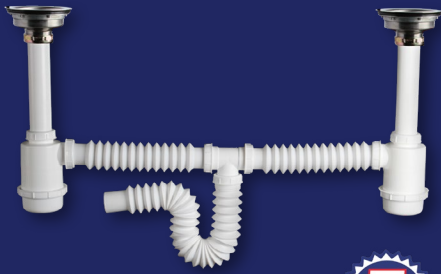

Code 2326 | **6** PCS

Drain

Double large bottle trap drain with two stainless steel sink strainers (1.8'/55 cm extension).

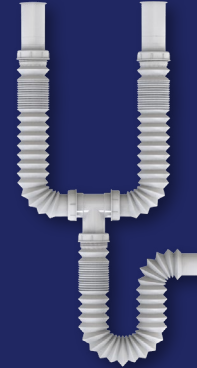

Code 2353 | **15** PCS

Drain

Flexible twin trap with 1.8'/55 cm extension.

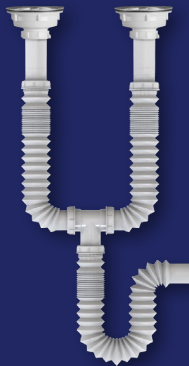

Code 2352 | **10** PCS

Drain

Flexible twin trap with 1.8'/55 cm extension and two combined sink strainers.

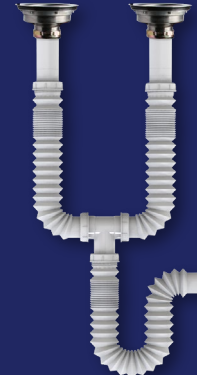

Code 2351 | **10** PCS

Drain

Flexible twin trap with 1.8'/55 cm extension and two stainless steel sink strainers.

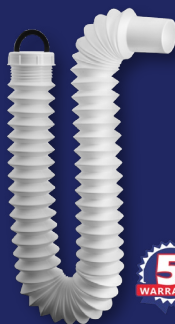

Code 2944 | **50** PCS

Extension

Universal flexible trap (2.6'/80 cm).



Code 2945 | **50** PCS

Extension

Flexible trap for washboard sink (2.6'/80 cm).



Plain ends!



Code 3345 | 35 PCS

Extension

Universal flexible trap in chrome finish (2.6'/80 cm).



Code 2244 | 60 PCS

Extension

Universal flexible trap (1.8'/55 cm).

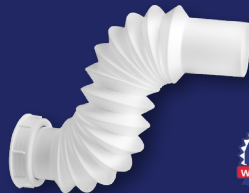

Code 2215 | 80 PCS

Extension

Universal flexible trap (0.82'/25 cm).



Code 2265 | 60 PCS

Extension

Universal flexible trap (1.8'/55 cm).



Code 2311 | 30 PCS

Strainer

Without cover for washboard sink.

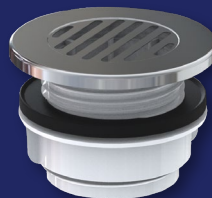

Code 2312 | 30 PCS

Strainer

With stainless steel cover for washboard sink.



Code 2212 | 35 PCS

Tailpiece

Zero Leakage with white grid, without overflow holes. **For vessel sink.**

Céspol ZERO

Without overflow holes!

Code 2220 | 70 PCS

Tailpiece

With stainless steel cover (for bathroom sink).

Code 2214 | 70 PCS

Tailpiece

Zero Leakage with stainless steel cover (for bathroom sink).

Code 2246 | 45 PCS

Tailpiece

Zero Leakage with stainless steel cover (for kitchen sink).

Code 2301 | 70 PCS

Flanged tailpiece

1 1/2" x 11.8" (30 cm) rigid pipe for kitchen sink.

Code 2498 | 60 PCS

Flanged tailpiece

1 1/2" x 3.9" (10 cm) rigid pipe for kitchen sink.

Code 2302 | 90 PCS

Flanged tailpiece

1 1/2" x 5.9" (15 cm) rigid pipe for kitchen sink.

Code 2300 | 90 PCS

Flanged tailpiece

1 1/2" x 7.9" (20 cm) rigid pipe for kitchen sink.

Code 2299 | 70 PCS

Flanged tailpiece

1 1/2" x 9.8" (25 cm) rigid pipe for kitchen sink.

MORE RESISTANT!
 Made with ABS

Code 2237 | 50 PCS

Rigid extension

1 1/2" x 5.9" (15 cm) rigid pipe for kitchen sink.

Code 2238 | 50 PCS

Rigid extension

1 1/2" x 7.9" (20 cm) rigid pipe for kitchen sink.

Code 2289 | 50 PCS

Rigid extension

1 1/2" x 9.8" (25 cm) rigid pipe for kitchen sink.

Code 2240 | 50 PCS

Rigid extension

1 1/2" x 11.8" (30 cm) rigid pipe for kitchen sink.

Code 2241 | 60 PCS

Rigid extension

1 1/2" x 9.8" (25 cm) rigid pipe with slip nut and gasket for bathroom or kitchen sink.



Code 2224 | 50 PCS

Rigid extension

1 1/4" x 5.9" (15 cm) for bathroom sink.

Code 2222 | 50 PCS

Rigid extension

1 1/4" x 7.9" (20 cm) for bathroom sink.

Code 2232 | 50 PCS

Rigid extension

1 1/4" x 11.8" (30 cm) for bathroom sink.



Code 2428 | 60 PCS

Foot valve

Acetal resin foot valve with strainer (3/4" fittings).

Code 2429 | 30 PCS

Foot valve

Acetal resin foot valve with strainer (1" fittings).



Code 2439 | 10 PCS

Fill valve

With 1/2" NPT-NPS threaded float ball with fixing nut and rod.

Code 2447 | 10 PCS

Fill valve

With 3/4" NPT-NPS threaded float ball with fixing nut and rod.



Code 2438 | 50 PCS

Fill valve

1/2" thread (NPT-NPS) with fixing nut.

Code 2446 | 50 PCS

Fill valve

3/4" thread (NPT-NPS) with fixing nut.



Code 2472 | 50 PCS

Roll holder

For toilet paper (plain).



Code 2472C | 50 PCS

Roll holder

For toilet paper (chrome).



Code 2476 | 10 PCS

Roll holder kit

With chrome bracket (for toilet paper).



Code W2486 | 50 PCS

Set of bolts

Polypropylene raw material coupling bolts.



Code 2720A | 125 PCS

Plastic sieve

For bathroom sink (3-pack).

**Flexible
toilet seal**



- ✓ Ring with patented encapsulated cushion.
- ✓ Super flexible and robust (withstands up to 17 tons).
- ✓ Zero leaks, zero odor.
- ✓ Allows for several installation attempts.
- ✓ Made with hydrogenated PVC.
- ✓ For 2" and 3" toilets.

Code 2575 | 50 PCS

Flexible toilet seal

**Flanges with
Flexible toilet seal**

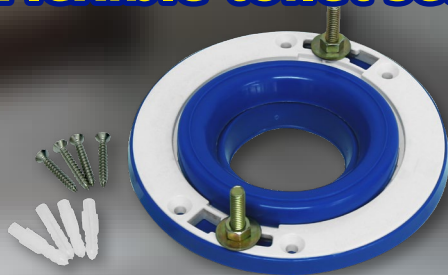

- ✓ Pipe misalignment tolerance of up to 2"/5 cm in any direction.
 - ✓ Engineered rubber that guarantees a longer service life.
- Patent and RMU pending**

Code 2577 | 40 PCS

Universal flange

For 3" and 4" drain.

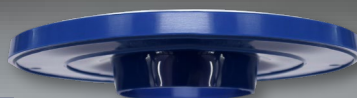

Code 2579 | 28 PCS

Glue-in flange

For 4" standard drain (American).



**ULTRA
RESISTANT!**



Code 2486 | **120** ^{BAG}

Wall anchor

Bag with 1/4" fixing anchors.
Contains 100 units.

Code 2487 | **120** ^{BAG}

Wall anchor

Bag with 5/16" fixing anchors.
Contains 75 units.

Code 2488 | **120** ^{BAG}

Wall anchor

Bag with 3/8" fixing anchors.
Contains 50 units.



Code 2502A | **50** ^{PCS}

Sink strainer

Practical (stainless steel and polypropylene raw material) with 3.9"/10 cm flanged tailpiece.



Code 2471 | **40** ^{PCS}

Angle valve

1/2" x 1/2".
Made with POM raw material.



Code 2474G | **40** ^{PCS}

Hose bibb

1/2" gray.
Made with POM raw material.



Code 2489 | **25** ^{PCS}

Heater drain valve

3/4" x 3/4".
Made with POM raw material.



Code 2471C/F | **40** ^{PCS}

Angle valve set

Made with POM raw material.



Quality & Trust

FLUSH VALVE KIT

Technical specifications

Material: White polypropylene (virgin) and hydrogenated PVC (for the black Flexi-Flapper).

Differentiating attributes:

- Maintains efficiency either with low (3.5 PSI/0.25 kg/cm²) or high (100 PSI/7 kg/cm²) pressure.
- Fill valve with rotating top for easy adjustment and maintenance, no bolts involved.
- Works great even with raw water (containing specks of dirt).
- No tools needed for installation.
- 4" float ball and 3/8" plastic coupling bolts.



NOM

NOM-010-CONAGUA-2000



FILL VALVE



8.5" GIRA JACK ADJUSTABLE.

LEVER



CHROME HANDLE



WHITE HANDLE

BOLTS

PLASTIC



TROPICALIZED



FLUSH VALVE



2"



3"

FLUSH VALVE KITS

www.fleximatic.com.mx



NOM
NOM-010-CONAGUA-2000



Code 2724 15 PCS
Flush valve kit

Zero Leakage with Flexi-Flapper and 8.5" valve.



NOM
NOM-010-CONAGUA-2000



Code 2723 8 PCS
Flush valve kit

Zero Leakage with Flexi-Flapper, angled arm for curved tanks and 8.5" valve (boxed).



Code 2406 50 PCS
Flexi-Flapper



PATENT No.
MX234685

- ✓ The only one with patented perfect sealing verified through lab tests.
- ✓ Fast and easy installation.
- ✓ Meets the highest quality standards.
- ✓ Made with polypropylene raw material and hydrogenated PVC (not vinyl, which stiffens and deteriorates).

Water pressure inflates the flapper, creating a perfect seal

Bulb flapper
Engineered rubber
ULTRA FLEXIBLE

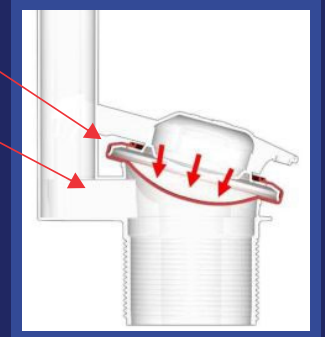

Code 2716 60 PCS
Fill valve

8.5" adjustable *Gira Jack*.



Code 2715 30 PCS
Flush valve

With 2" Flexi-Flapper.



Code 2722 15 PCS
Flush valve kit

Zero Leakage with Flexi-Flapper, chrome handle (30°) and sponge gasket.



Code 2724P | 15 PCS
Flush valve kit
With push button on top.



Code 2401 | 20 PCS
Push button
For tank with top hole (38 mm).



- ✓ Works with low and high water pressure.
- ✓ Single flush push button on top (chrome).
- ✓ Tank fill system that restricts water flow as needed.
- ✓ Works great even with raw water (containing specks of dirt).



NOM-010-CONAGUA-2000



Code 2726 | 12 PCS
Flush valve kit
Zero Leakage with Flexi-Flapper and 8.5" anti-siphon valve, 2" discharge and sponge gasket.



Ideal for toilet manufacturers!

Flush valve kit



Anti-siphon Zero Leakage NOM-010-CONAGUA-2000

- ✓ Pioneering *fill valve with anti-siphon system* that prevents water backflow.
- ✓ Tank fill system that restricts water flow as needed.
- ✓ Works great even with raw water (containing specks of dirt).
- ✓ Works with low and high water pressure.

2" UNIVERSAL FLAPPER

- ✓ Universal adjustment system that adapts to any 3" flush valve.
- ✓ Water saving knob: flushes from 1 to 1.6 US gal (4 to 6 L).
- ✓ Resistant to chlorine and other substances.



Code 2710 | 20 PCS
Universal flapper
2".



FLUSH VALVE KITS

www.fleximatic.com.mx



Code 2492 | 20 PCS

Bulb flapper
2".



WITH EASY-DETACH STRAP!

Code 2463 | 20 PCS

Universal flapper
2" made with hydrogenated
PVC (yellow, bagged).



WITH EASY-DETACH STRAP!

Code 2464 | 20 PCS

Universal flapper
2" made with hydrogenated
PVC (orange, bagged).

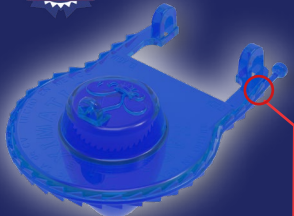

WITH EASY-DETACH STRAP!

Code 2415 | 40 PCS

Universal flapper
2" made with hydrogenated
PVC (blue).



WITH EASY-DETACH STRAP!

Code 2462 | 40 PCS

Universal flapper
2" made with hydrogenated
PVC (crystal).



Code 2416 | 10 PCS

Flapper
3" (blue).



Code 2416N I | 50 PCS

Flapper
3" (black).

3" UNIVERSAL FLAPPER

- ✓ Universal adjustment system that adapts to any 3" flush valve.
- ✓ Water saving knob: flushes from 1 to 1.6 US gal (4 to 6 L).
- ✓ Resistant to chlorine and other substances.



Code 2708 | **60** PCS
Universal flapper
3" Zero Leakage.



Code 2707 | **8** PCS
Flush valve kit
With 3" discharge
(boxed).

NOM
NOM-010-CONAGUA-2000



NOM
NOM-010-CONAGUA-2000

Code 2706 | **12** PCS
Flush valve kit
With 3" discharge.



NOM
NOM-010-CONAGUA-2000



Code 2701 | **20** PCS
Flush valve
3" discharge.

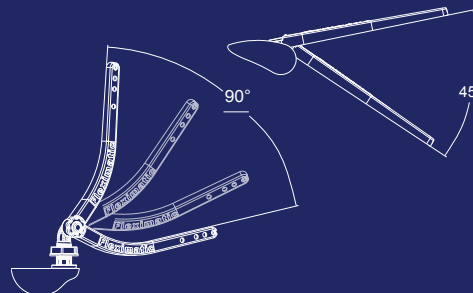

Multi-position lever

Allows you to adjust the angle of your lever according to your toilet tank design. Can be installed in front hole, corner hole and side hole tanks. In addition, its adjustment system is simple and makes it easy to install.



Code 2390 | **20** PCS
Multi-position lever
With chrome handle.



Code 2392 | **20** PCS

Patolux lever

With straight arm for toilet tank (chrome).



Code 2402 | **25** PCS

Lever

Straight arm for toilet tank (plain handle).

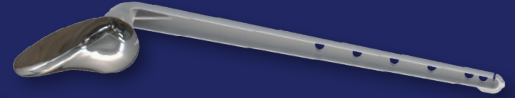

Code 2404 | **25** PCS

Lever

Straight arm for toilet tank (chrome handle).



Code 2562 | **50** PCS

Coupling kit

2" beveled gasket with coupling bolts.



Code 2411 | **50** PCS

Plastic float ball

4", reinforced with nut (does not include rod).



Code 2412 | **60** PCS

Plastic float ball

4", reinforced (does not include nut or rod).



Code 2449 | **30** PCS

Plastic float ball

6", reinforced with 9.8"/25 cm tropicalized rod.



Quality & Trust

FLOOR DRAINS



PATENT No. 247239

Universal Floor Drain

GRIDS

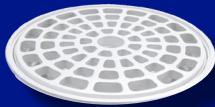

WHITE



STAINLESS STEEL COVER WITH BEVELED EDGE

STAINLESS STEEL COVER



MINIMALIST

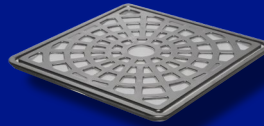

SQUARE



TABLE OF GENERAL WEIGHT RESISTANCE FOR EACH GRID TYPE.

ABS - Unchromed up to 330 lb/150 kg.	
PP + SS 430 30 gauge up to 660 lb/300 kg.	
SS 304 14 gauge up to 1,100 lb/500 kg.	

Maximum tested resistance (no impacts)

Technical specifications

Material:

White ABS plastic (virgin) and polypropylene.

Differentiating attributes:

- ✓ Ultra resilient to weather; it neither stiffens nor cracks in contact with water.
- ✓ Patented **Click-Lock** system to open the grid and perform maintenance without any tools.
- ✓ Fits 2", 3" and 4" pipe connections.
- ✓ If unused, it is recommended to detach the 2" pipe fitting in order to increase the water outlet diameter.

Central and South America:

For 2" and 4" USA standard pipe

BODY



UNIVERSAL
2" 3" and 4"

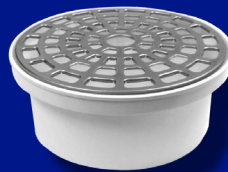

STRAIGHT TO PIPE
4"



Click-Lock for easier cleaning

EXTRA LARGE trap prevents clog

Fits pipe connections

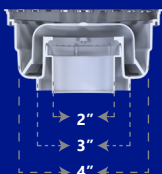

Water trap

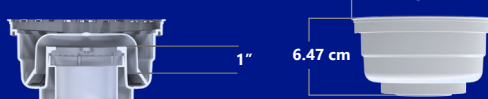

Find all codes in their new bagged presentation.

Universal (fits 2", 3" and 4")



Look for the anti-odor check valve (code 2260)

Code 2254 45 PCS



Universal drain
Grid with stainless steel cover (with hygienic lid).

Universal (fits 2", 3" and 4")



Look for the anti-odor check valve (codes 2550 & 2689CH)

Code 2684 45 PCS



Universal drain
Grid with stainless steel cover and beveled edge (with hygienic lid).

Universal (fits 2", 3" and 4")



Code 2258 45 PCS



Universal drain
White (with hygienic lid).

100% STAINLESS STEEL

Universal (fits 2", 3" and 4")



Code 2253 45 PCS



Universal drain
Stainless steel grid with beveled edge (with hygienic lid).

For 2" pipe



Code 2250C 60 PCS



"Swirl" drain
For 2" standard (American) piping.

Universal straight to pipe (2", 3" or 4")

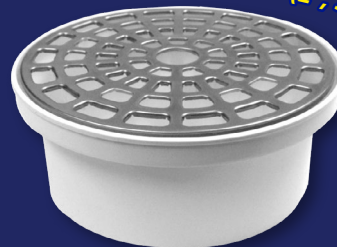

Code 2264C 50 PCS



Universal drain
For 2" standard (American) piping.

fleximatic®

Quality & Trust

New

Zero-odor drains

Up to 3 Anti-odor barriers

5 YEARS WARRANTY
AGAINST
MANUFACTURING DEFECTS.

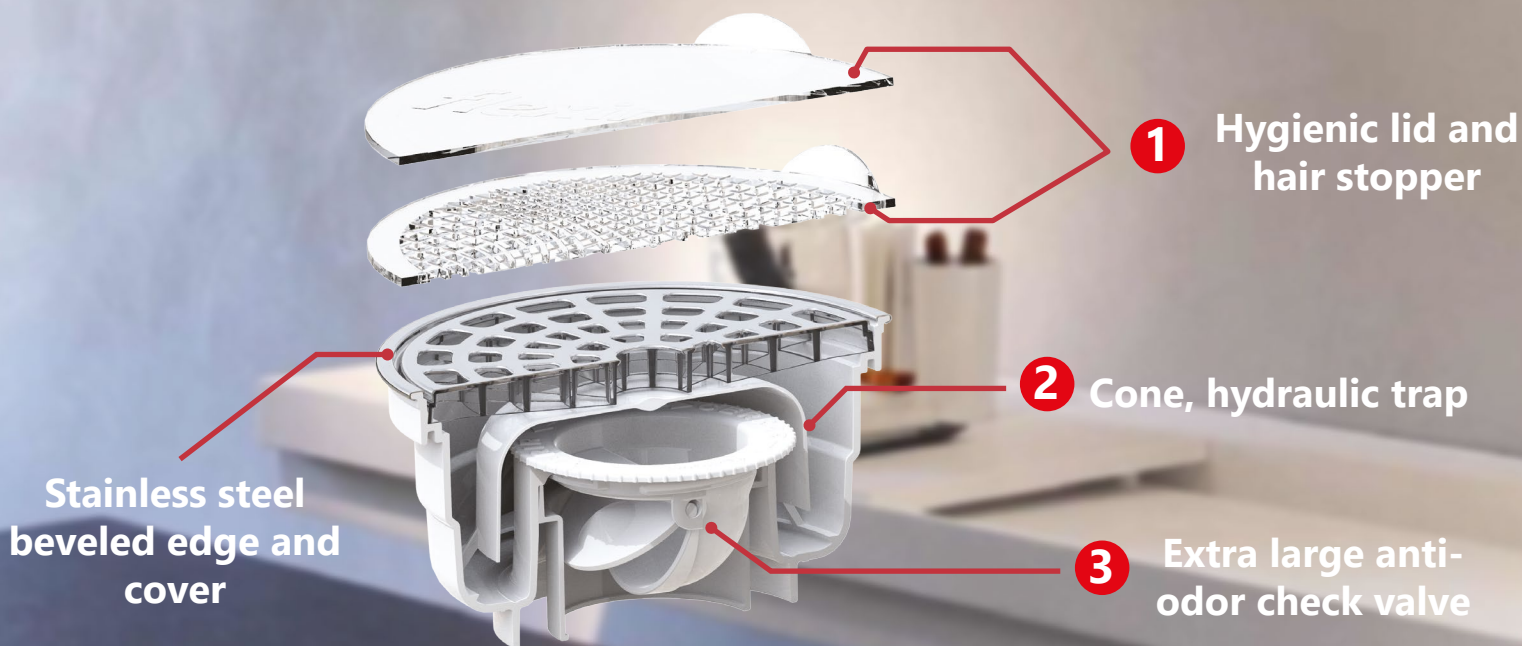

Code 2550 | 45 PCS

Universal Zero-odor drain with **Anti-odor check valve**, hygienic lid, hair stopper, and stainless steel grid and beveled edge



 /fleximatic

 /fleximatic

 /fleximatic

www.fleximatic.com.mx

FLOOR DRAINS



NEW!



Code 2313C | 15 PCS

Easy-install drain

For 2" standard (American) piping.



NEW!



Code 2314C | 15 PCS

Easy-install drain

Export code.
For standard (American) piping.



NEW!

**100%
STAINLESS
STEEL**

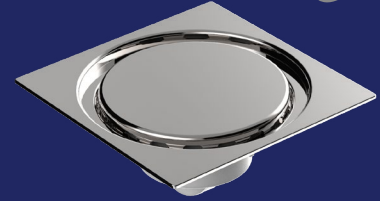

Code 2315 | 15 PCS

Easy-install drain

Square 4" x 4" (10 x 10 cm)
with stainless steel cover
(minimalist style).



**Compatible with 90%
of the drains on the
market!**



Code 2590 | 10 PCS

Coupling check valve

Universal anti-odor.



Code 2640 | 3 PCS

Outdoor drain

With stainless steel
cover.



Code 2209 | 10 PCS

Slip nut and gasket

4" for outdoor floor drain.
Installation on polypropylene
piping (raw material).



**100%
STAINLESS
STEEL**



Code 2619 | 35 PCS

Universal drain

Square with stainless steel
grid, retro style.

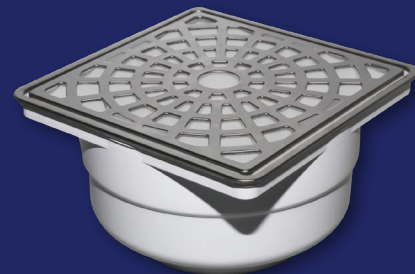

Code 2602 | 45 PCS

Universal drain

Square with stainless steel
cover and hygienic lid.

Code 2604 | 45 PCS

Universal drain

Square with stainless steel
cover and beveled edge
(without hygienic lid).





Quality & Trust

SIDE OUTLET DRAINS

Technical specifications

Material: White ABS plastic (virgin) and polypropylene.

Differentiating attributes:

- Ultra resilient to weather, and neither stiffens nor cracks in contact with water.
- Patented "Click-Lock" system to open the grid and perform maintenance without any tools.
- Direct 2" pipe outlet.
- Side outlet designed for use on upper floors.

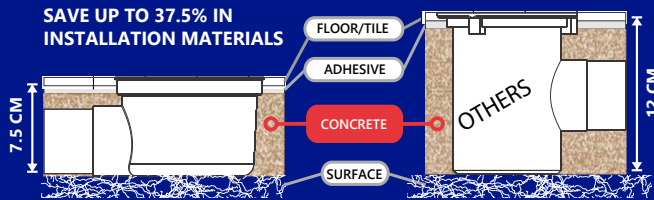

GRIDS

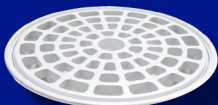

WHITE



STAINLESS STEEL COVER



PUSH



MINIMALIST

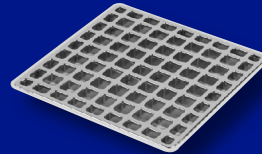

SQUARE



BODY



TRAP



SIDE OUTLET DRAINS

www.fleximatic.com.mx

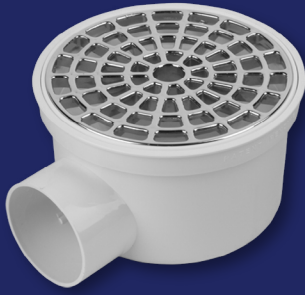

Code 2271 | 30 PCS

Side outlet drain
Kompakt, grid with stainless steel cover, classic style (without hygienic lid).



Code 2626C | 15 PCS

Flanged drain
For standard (American) piping.

**100%
STAINLESS
STEEL**



Code 2269C | 30 PCS

Side outlet drain
For standard (American) piping.



Code 2270C | 70 PCS

Side outlet drain
For standard (American) piping.

Code 2272C | 70 PCS

Side outlet drain
For standard (American) piping.

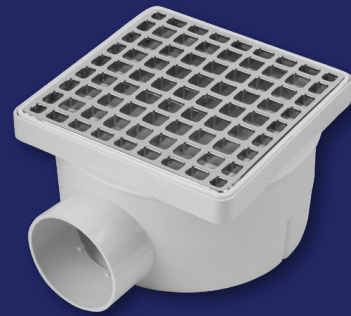

Code 2608 | 26 PCS

Side outlet drain
Kompakt, square (chrome) without hygienic lid.



Easy-install drains

- ✓ **Easy to install**
Convenient, simplified and quick
- ✓ **Anti-odor check**
Prevents odor and bugs from entering
- ✓ **Resistant and durable**
Stainless steel cover and beveled edge



Code 2313C

Easy-install drain
American model
Adapter included

Code 2314C

Easy-install drain with
stainless steel grid
American model
Adapter included

Universal Push floor drain



Acetal resin core (POM raw material) and stainless steel cover

100% stainless steel

✓ Anti-odor gasket

✓ Rust-proof brass pop-up system



Push system



Code 2249 | 15 PCS
Universal Push floor drain

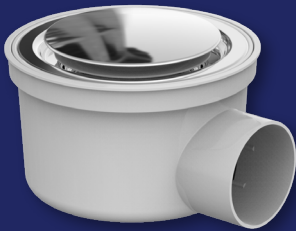

Code 2280 | 30 PCS
Side outlet drain
Kompakt Push.

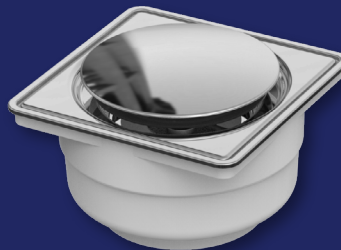

Code 2248 | 45 PCS
Universal drain
Square Push.



Code 2663 | 45 PCS
Universal drain
Minimalist style with beveled edge (with hygienic lid).



100% STAINLESS STEEL

Code 2268C | 30 PCS
Side outlet drain
For standard (American) piping.



100% STAINLESS STEEL

Code 2611 | 26 PCS
Side outlet drain
Kompakt square minimalist style (without hygienic lid).



NEW!

Code 2491 | 10 PCS
Outdoor faucet
1/2" PVC 1/4 turn with brass insert.



Code 2629 | 16 PCS

Linear drain
Minimalist style with anti-odor check valve 11.8" x 3.1" (30 x 8 cm).

Anti-odor check

- ✓ Prevents viruses, bacteria, bugs and odor from entering
- ✓ Made with ABS

Code 2627 | 16 PCS

Linear drain
Minimalist style with anti-odor membrane 11.8" x 3.1" (30 x 8 cm).

- ✓ Prevents viruses, bacteria, bugs and odor from entering
- ✓ Made with high-quality silicone
- ✓ Flexible and durable

Code 2218A | 30 PCS

Flexible trap
With small bottle and push button.

Code 2235A | 25 PCS

Flexible trap
With push button.

Code 2212A | 35 PCS

Tailpiece
Zero Leakage with push button.

Backwater valve (4" and 6")



- ✓ Prevents wastewater backflow and flooding from heavy rain
- ✓ Stops rodents and bugs from entering
- ✓ Flap proper operation guaranteed thanks to its safety gasket
- ✓ Cleanout handle that allows for easy opening and maintenance



Code 2646 | 4 PCS
Backwater valve

4" (ABS raw material) for standard piping (American).

Code 2647 | 1 PC
Backwater valve

6" (ABS raw material) for standard piping (American).



Code 2649 | 1 PC

Flap
 For 6" backwater valve.
 Spare part.

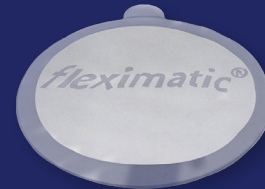

Code 2207 | 30 PCS

Hygienic lid
 Round (transparent).



Code 2145 | 30 PCS

Hygienic lid
 Square (white).

Code 2277



Code 2277 | 30 PCS

Hygienic lid (3-pack)
 Round (white).



Code 2691 | **30** PCS

Sieve
"Garden" sieve for drain
(transparent).



Code 2256 | **10** PCS

Classic grid
With stainless steel cover
for universal drain.



Code 4490 | **25** PCS

Grid
4 3/4" stainless steel.



Code 4588 | **25** PCS

Grid
3 1/2" stainless steel.

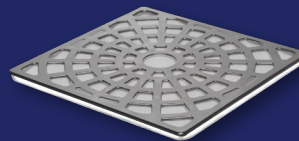

Code 2597 | **30** PCS

Grid
4 3/4" x 4 3/4" stainless steel.



Code 2420T | **50** PCS

Faucet sprayer
For kitchen sink (transparent).



Code 2420V | **50** PCS

Faucet sprayer
For kitchen sink (green).



Code 2420 | **50** PCS

Faucet sprayer
For kitchen sink (blue).



Code 2410 | **100** PCS

Rubber adapter
1 1/4" x 1 1/2" adapter #1.



Code 2426 | **50** PCS
Rubber adapter
 1 1/4" x 2" adapter #2.



Code 2448 | **50** PCS
Rubber adapter
 1 1/2" x 2" adapter #3.

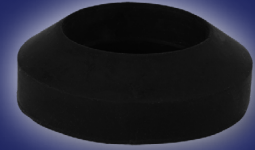

Code 2563 | **50** PCS
Beveled gasket
 For toilet 2".

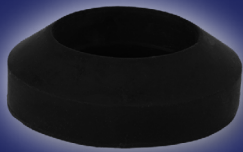

Code 2566 | **40** PCS
Beveled gasket
 For toilet 3".



Code 2561 | **50** PCS
Sponge gasket
 3".



Code 2413 | **100** PCS
Tropicalized rod
 1/4" x 6".



Code 544 | **10** PCS
Mounting bracket
 Universal aluminum bracket
 for bathroom sink.



Code 2478 | **100** PCS
Coach screw
 2 1/2" tropicalized for
 toilet.

Code 2479 | **100** PCS
Coach screw
 3 1/2" tropicalized for
 toilet.



Code 2480 | **100** PCS
Brass-plated screw
 Coupling screw for toilet.



Code 2482 | **50** PCS
Sink hole cover
 Made with sheet metal.



Code 2494 | **50** PCS
Reinforced bracket
 For bathroom sink.

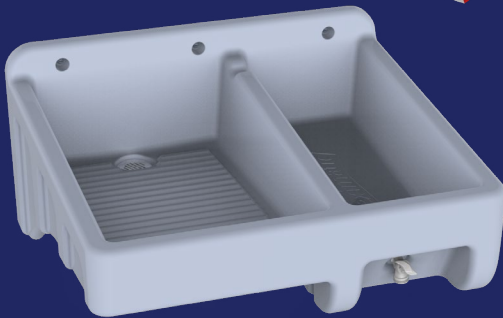

Code 2028 | **1** PC
Fleximatic Washboard



Code 2424 | **120** PCS
Universal connector
 $1\frac{1}{2}'' - 1\frac{1}{4}'' \times 2''$.

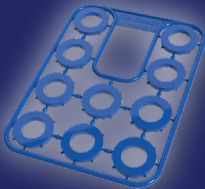

Code 2587 | **50** PCS
Hose gasket
 10 pieces.

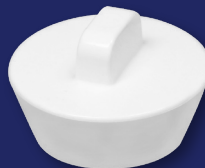

Code 2594 | **50** PCS
Bathroom sink plug



Code 2588 | **50** PCS
Y coupling
 For hose or washing machine.
 Made with acetal resin.



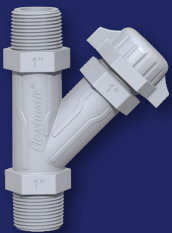

NEW!

Code 2586 60 PCS

Y Connector
Made with reinforced polypropylene raw material.

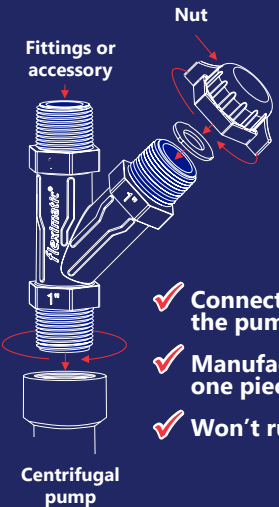

Fittings or accessory
Nut
Centrifugal pump

- ✓ Connects directly to the pump
- ✓ Manufactured in one piece
- ✓ Won't rust



Code 2743 25 PCS

Hair snare



NEW!

Code 2490 10 PCS

Outdoor faucet
1/2" rising stem (reinforced acetal resin).



NEW!

Code 4407 50 PCS

Lock nut
For basket strainer.



NEW!

Code 4412 50 PCS

Slip-joint nut
With washer.



NEW!

Code 4401 20 PCS

Set of accessories
Economical set for bathroom.



NEW!

Code 4202 25 PCS

Set of accessories
Zinc-crystal Plus set for bathroom.



Convenience at home

Presenting the **Fleximatic Washboard** Code 2028

More than a product, a **solution**

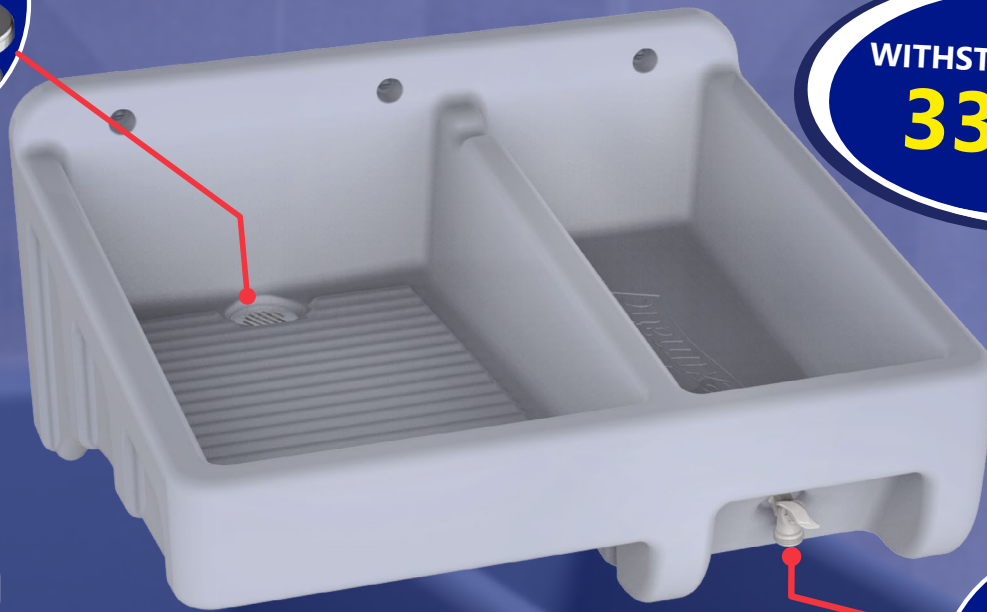

WITHSTANDS UP TO
330 lb!



- ✓ **Tough and functional**
Time-saving installation
- ✓ **UV protection coating**
Longer service life
- ✓ **5.3 US gal (20 L) sink capacity**

✓ **Installation kit included:**

- Stainless steel grid*
- Gasket and tailpiece*
- Hose bibb*
- Set of plugs and screws*

Follow us on social media



/fleximatic



/fleximatic



/fleximatic

**BATHROOM
SINK**
1
YEAR
WARRANTY

Code 3204 15 PCS

Contains:

- 2 water hoses w/ nylon insert for bathroom sink (1/2" x 1/2" x 40 cm).
- 2 zinc angle valves (1/2" x 1/2").
- 1 flexible bathroom sink trap w/ small bottle, 1.8'/55 cm extension and stainless steel cover.
- 1 rubber adapter (#3) 1 1/2" x 2".
- 1 PTFE Fleximatic tape 7 m x 1/2" (white).

KITCHEN SINK
1
YEAR
WARRANTY

Code 3207 15 PCS

Contains:

- 2 water hoses w/ nylon insert for kitchen sink (1/2" x 1/2" x 50 cm).
- 2 zinc angle valves (1/2" x 1/2").
- 1 flexible kitchen sink P-trap w/ 2.6'/80 cm extension, flanged tailpiece and stainless steel sink strainer.
- 1 rubber adapter (#3) 1 1/2" x 2".
- 1 PTFE Fleximatic tape 7 m x 1/2" (white).

DOUBLE BOWL SINK
1
YEAR
WARRANTY

Code 3212 6 PCS

Contains:

- 2 water hoses w/ brass insert for kitchen sink (1/2" x 1/2" x 50 cm).
- 2 zinc angle valves (1/2" x 1/2").
- 2 combined sink strainers w/ 3.9"/10 cm flanged tailpiece.
- 1 rubber adapter (#3) 1 1/2" x 2".
- 1 PTFE Fleximatic tape 7 m x 1/2" (white).
- 1 standard (American) drain.
- 1 2.6'/80 cm flexible extension for bathroom/kitchen sink.

TOILET
1
YEAR
WARRANTY

Code 3209 8 PCS

Contains:

- 1 large wax ring w/ flange.
- 1 zinc angle valve (1/2" x 1/2").
- 1 water hose w/ nylon insert for toilet (1/2" x 15/16" x 40 cm).
- 2 2 1/2" coach screws for toilet.
- 1 PTFE Fleximatic tape 7 m x 1/2" (white).
- 1 2" beveled gasket for toilet.
- 1 "Maxtor" flush valve kit (white).

**BATHROOM
SINK**
1
YEAR
WARRANTY

Code 3205 15 PCS

Contains:

- 2 water hoses w/ nylon insert for bathroom sink (1/2" x 1/2" x 40 cm).
- 2 acetal resin angle valves (1/2" x 1/2").
- 1 rubber adapter (#3) 1 1/2" x 2".
- 1 PTFE tape 7 m x 1/2".
- 1 flexible bathroom sink trap w/ small bottle, 1.8'/55 cm extension and stainless steel cover.

DOUBLE BOWL SINK
1
YEAR
WARRANTY

Code 3210 7 PCS

Contains:

- 2 water hoses w/ brass insert for kitchen sink (1/2" x 1/2" x 50 cm).
- 2 acetal resin angle valves (1/2" x 1/2").
- 2 combined sink strainers (stainless steel and PP w/ 3.9"/10 cm flanged tailpiece).
- 1 rubber adapter (#3) 1 1/2" x 2".
- 1 PTFE tape 7 m x 1/2".
- 1 standard (American) kitchen sink drain w/ flexible 2.6'/80 cm extension.

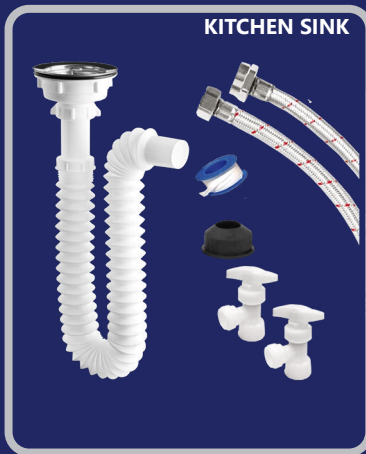

KITCHEN SINK

1 YEAR WARRANTY

Code 3218 | 15 PCS

Contains:

- 2 water hoses w/ brass insert for kitchen sink (1/2" x 1/2" x 50 cm).
- 2 acetal resin angle valves (1/2" x 1/2").
- 1 rubber adapter (#3) 1 1/2" x 2".
- 1 PTFE tape 7 m x 1/2".
- 1 2.6"/80 cm flexible kitchen sink P-trap w/ 3.9"/10 cm flanged tailpiece and stainless steel/PP sink strainer.



TOILET

1 YEAR WARRANTY

Code 3219 | 25 PCS

Contains:

- 1 water hose w/ nylon insert for toilet (1/2" x 1/2" x 40 cm).
- 1 acetal resin angle valve (1/2" x 1/2").
- 1 hydrogenated PVC Flexible toilet seal.
- 1 PTFE tape 7 m x 1/2".
- 2 2 1/2" x 1/4" coach screws for toilet.



TOILET

1 YEAR WARRANTY

Code 3220 | 10 PCS

Contains:

- 1 hydrogenated PVC Flexible toilet seal.
- 1 acetal resin angle valve (1/2" x 1/2").
- 1 water hose w/ nylon insert for toilet (1/2" x 7/8" x 40 cm).
- 2 2 1/2" x 1/4" coach screws for toilet.
- 1 PTFE tape 7 m x 1/2".
- 1 2" beveled gasket for toilet.
- 1 "Maxtor" flush valve kit (white).

New single-handle centersets for kitchen sink!





Quality & Trust

Universal Flange

Code 2577

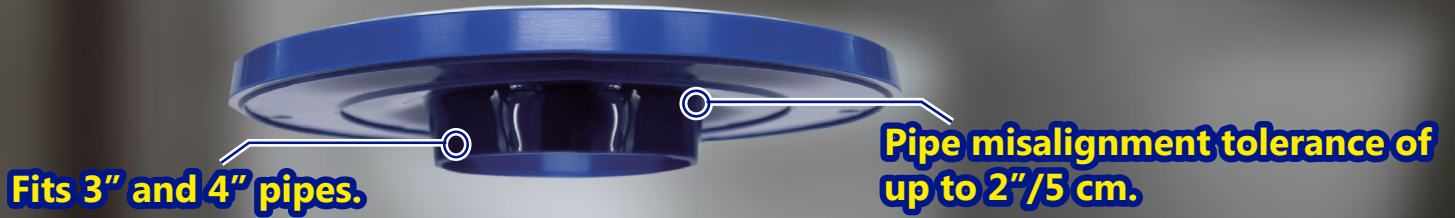
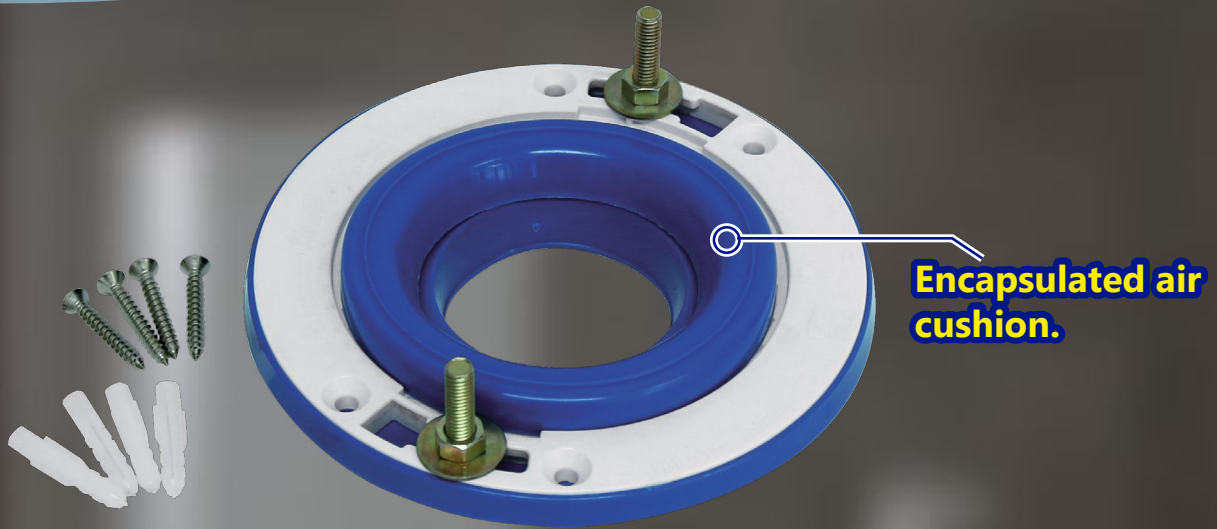

- ✓ Withstands up to 17 tons without deformation.
- ✓ Allows for several installation attempts.
- ✓ Engineered rubber that guarantees a longer service life.



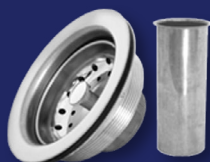

Code 4406 | 25 PCS

Sink strainer

Stainless steel with 3.9"/10 cm flanged tailpiece.



Code 4402 | 25 PCS

Sink strainer

White with stainless steel cover and 3.9"/10 cm flanged tailpiece.



Code 4427 | 20 PCS

Basket top

Stainless steel (with stem).



Code 4502 | 50 PCS

Grid

Stainless steel for 2" pipe.



Code 2418 | 25 PCS

Old style flange

For gate valve.



Code 4200 | 16 PCS

Faucet

Zinc/ABS raw material, quick opening, classic style for bathroom sink.



Code 4201 | 16 PCS

Faucet

Zinc/ABS raw material, quick opening, retro style for bathroom sink.



Code 4487 | 16 PCS

Faucet

Zinc/ABS raw material, quick opening, cane style neck for bathroom sink.



Code 4530 | 20 PCS

Faucet

Brass, cane style neck and classic handles for bathroom sink.



Code 4531 | **20** PCS

Faucet

Brass, cane style neck and retro handles for bathroom sink.



Code 4532 | **20** PCS

Faucet

Brass, cane style neck and white lever handles for bathroom sink.



Code 4429 | **12** PCS

ABS Faucet

Quick opening for bathroom sink (white).



Code 4473 | **20** PCS

Faucet

Zinc, quick opening, cross handles and flexible neck for bathroom sink.



Code 4474 | **20** PCS

Faucet

Zinc, quick opening, QUEEN handles and flexible neck for kitchen sink.



Code 4475 | **20** PCS

Faucet

Zinc, quick opening, lever handles and flexible neck for kitchen sink.



Code 4482 | **12** PCS

Faucet

Zinc/ABS raw material, goose style neck for kitchen sink (rising stem).



Code 4483 | **10** PCS

Faucet

Acetal POM raw material, quick opening with cover and goose style neck for kitchen sink.



Code 4484 | **10** PCS

Faucet

Acetal POM raw material, quick opening with cover and cobra style neck for kitchen sink.



Code 4485 | 10 PCS

Faucet

Acetal POM raw material, quick opening with cover and swan style neck for kitchen sink.



NEW!



Code 4533 | 12 PCS

Faucet

Brass, cane style neck and classic handles for kitchen sink.



NEW!



Code 4534 | 12 PCS

Faucet

Brass, cane style neck and retro handles for kitchen sink.



NEW!



Code 4535 | 12 PCS

Faucet

Brass, cane style neck and white lever handles for kitchen sink.



NEW!



Code 4536 | 12 PCS

Faucet

Brass, cobra style neck and classic handles for kitchen sink.



NEW!



Code 4537 | 12 PCS

Faucet

Brass, cobra style neck and retro handles for kitchen sink.



NEW!



Code 4538 | 12 PCS

Faucet

Brass, cobra style neck and white lever handles for kitchen sink.



NEW!



Code 4503 | 6 PCS

Faucet

Single handle, flexible neck for kitchen sink.



NEW!



Code 4504 | 6 PCS

Faucet

Single handle for kitchen sink.



Code 4505 | 12 PCS

Faucet

Single handle faucet for bathroom sink.



Code 4506 | 12 PCS

Faucet

Single handle faucet with curved neck for kitchen sink.



Code 4430 | 12 PCS

ABS faucet

Quick opening for kitchen sink (brown).



Code 4431 | 12 PCS

ABS faucet

Quick opening for kitchen sink (white).



Code 4432 | 12 PCS

ABS faucet

Quick opening for kitchen sink (gray).

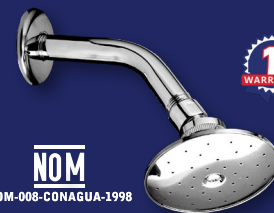

NOM

NOM-008-CONAGUA-1998

Code 4415 | 10 PCS

Zinc shower head

RASO model with rigid arm and flange (chrome).



NOM

NOM-008-CONAGUA-1998

Code 4416 | 10 PCS

Zinc shower head

CUBI model with rigid arm and flange (chrome).



NOM

NOM-008-CONAGUA-1998

Code 4417 | 10 PCS

Zinc shower head

CLASSICA model with rigid arm and flange (chrome).



NOM

NOM-008-CONAGUA-1998

Code 4418 | 10 PCS

Zinc shower head

INNO model with rigid arm and flange (chrome).



NOM
NOM-008-CONAGUA-1998



Code 4419 | 10 PCS

Zinc shower head
CONTEMPO model with rigid arm and flange (chrome).



NOM
NOM-008-CONAGUA-1998



Code 4409 | 40 PCS

Shower head
Flat, easy clean (chrome).



NOM
NOM-008-CONAGUA-1998



Code 4433 | 20 PCS

Shower head
Convex, easy clean (chrome).



NOM
NOM-008-CONAGUA-1998



Code 4434 | 20 PCS

Shower head
Easy clean (white).



Code W4404 | 20 PCS

Flange and arm
Chrome metal arm with stainless steel flange for shower head (in blister).



Code 4422 | 50 PCS

Angle valve
Brass $\frac{1}{2}'' \times \frac{1}{2}''$, rising stem with zinc handle.



Code 4424 | 100 PCS

Angle valve
Brass $\frac{1}{2}'' \times \frac{1}{2}''$, quick opening with zinc handle.



Code 2432 | 100 PCS

Cartridge
Brass, standard (American) for gate valve (rising stem).



Code 2434 | 100 PCS

Cartridge
Brass, small for bathroom sink faucet #42 (rising stem).



Code 2435 | **50** PCS
Cartridge

Brass, large for gate valve #55 (old style, rising stem).



Code 2451 | **100** PCS
Cartridge

Brass, small for gate valve #312 (rising stem).



Code 4601 | **60** PCS
Bibcock

$\frac{3}{4}$ " x $\frac{1}{2}$ " slow opening (brass finish).



Code 4602 | **40** PCS
Bibcock

$\frac{3}{4}$ " x $\frac{1}{2}$ " slow opening (nickel-plate).



Code 4641 | **20** PCS
Flexi-Bibcock

Brass $\frac{3}{4}$ " x $\frac{1}{2}$ ", quick opening.



NEW!



Code 4611 | **10** PCS
Bibcock

$\frac{3}{4}$ " x $\frac{1}{2}$ " quick opening (nickel-plate).



Code 4441 | **50** PCS
Compression coupling
 $\frac{1}{2}$ ".



Code 4442 | **50** PCS
Compression coupling
 $\frac{3}{4}$ ".



Code 4443 | **50** PCS
Compression coupling
1".



Code 7011 | **250** PCS
PTFE tape
7 m (22.9') x $\frac{1}{2}$ ", yellow.

Code 7012 | **250** PCS
PTFE tape
7 m (22.9') x $\frac{3}{4}$ ", yellow.

Code 7001 | 250 PCS

PTFE tape

7 m (22.9') x 1/2", white.



Code 7002 | 250 PCS

PTFE tape

7 m (22.9') x 3/4", white.



Code 7006 | 250 PCS

PTFE tape

13 m (42.6') x 1" white.

Code 8360 | 200 PCS

Insulating tape

18 m x 19 mm (59' x 3/4").

Code 4556 | 50 PCS

Check valve

Brass 1/2".

Code 4557 | 80 PCS

Check valve

Brass 3/4".

Code 4558 | 20 PCS

Check valve

Brass 1".

Code 4559 | 10 PCS

Check valve

Brass 1 1/4".

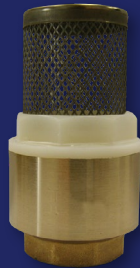

Code 4560 | 10 PCS

Check valve

Brass 1 1/2".



Code 2442 | 50 PCS

Relief valve

Brass body 1/2" for water heater.

Code 4131 | 100 PCS

Water hose

With brass insert 1/2" x 1/2" x 50 cm for kitchen sink.

Code 4132 | 100 PCS

Water hose

1/2" x 1/2" x 40 cm (bathroom sink). With nylon insert.

Code 4133 | 100 PCS

Water hose

1/2" x 7/8" x 35 cm for toilet. With nylon insert.

Code 4136 | 100 PCS

Water hose

With brass insert 1/2" x 1/2" x 40 cm (bathroom sink).

Code 4138 | 50 PCS

Water hose

"Y" hose with brass insert for bathroom/kitchen sink.

Code 4137 | 100 PCS

Water hose

With brass insert 1/2" x 7/8" x 35 cm for toilet.

Code 4139 | 50 PCS

Water hose

Supply line with brass insert 1/2" x 1/2" x 100 cm for bathroom/kitchen sink.



Braided aluminum

Code 4150 | 50 PCS

Water hose

1/2" x 1/2" x 40 cm (bathroom sink). **With brass insert.**



Braided stainless steel

Code 4151 | 50 PCS

Water hose

1/2" x 1/2" x 50 cm (bathroom sink). **With brass insert.**

Code 4152 | 50 PCS

Water hose

1/2" x 15/16" x 35 cm (for toilet). **With brass insert.**

Code 4140 | 50 PCS

Water hose

1/2" x 1/2" x 40 cm (bathroom sink).



Braided aluminum

Code 4141 | 50 PCS

Water hose

1/2" x 1/2" x 50 cm (bathroom sink). **With brass insert.**

Code 4142 | 50 PCS

Water hose

1/2" x 15/16" x 35 cm (for toilet). **With brass insert.**



Braided POM raw material

Code 4153 | 100 PCS

Water hose

1/2" x 1/2" x 45 cm polyacetal resin (for bathroom sink).

Code 4154 | 100 PCS

Water hose

1/2" x 1/2" x 55 cm polyacetal resin (for kitchen sink).

Code 4156 | 50 PCS

Water hose

1/2" x 1/2" x 100 cm polyacetal resin.



Code 4155 | 100 PCS

Water hose

1/2" x 7/8" x 40 cm polyacetal resin (for toilet).

Code 4157 | 50 PCS

Water hose

Polyacetal resin Y water hose 1/2" x 1/2" x 1/2".



Code 4160 | 50 PCS

Connector

"Y" supply hose for washing machine.



Code 4161 | 50 PCS

Connector

Supply hose for washing machine 4.9 ft (1.5 m).



Code 4481 | 12 PCS

Zinc/ABS quick opening faucet with goose style neck for kitchen sink.



Code 4478 | 10 PCS

ABS single handle faucet w/o cover for kitchen sink (chrome).



Code 4486 | 16 PCS

"Deluxe" zinc/ABS quick opening faucet for bathroom sink.



Code 4456 | 10 PCS

"Minimalist" ABS rigid trap for bathroom sink (chrome).



Code 4457 | 20 PCS

"Minimalist" ABS rigid trap for vessel sink (chrome).

fleximatic
Quality & Trust

**Drain odor?
Worry no more!**

**ANTI-ODOR
CHECK VALVE
FOR DRAINS**

Code 2590

✓ Prevents odor, bugs, viruses and bacteria from entering



Extra-large check valve
For Fleximatic Universal drain



Small check valve
For generic drains with 2" outlet

5 YEARS WARRANTY
AGAINST
MANUFACTURING DEFECTS.

Fittings

CPVC, PVC and PPR Which to choose?

When installing the water supply piping in your construction project or while redesigning your home, you probably went through the moment of choosing the proper pipes and connections to bring water anywhere you needed.

It is essential not to overlook the importance of these components, and that is why **Fleximatic** wants to share with you the uses of PVC, CPVC and PPR connections.

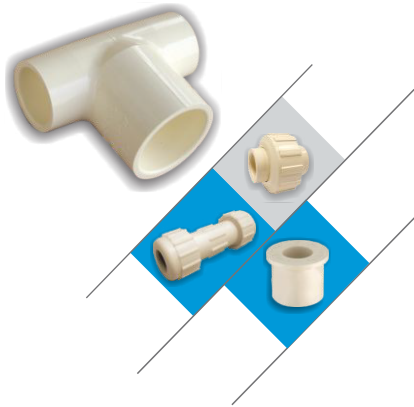

CPVC

Characteristics:

Chlorinated polyvinyl chloride (CPVC) has characteristics similar to those of PVC, however, because chlorine is one of its components, it possesses a stronger chemical structure.

Suggested uses:

- It is ideal for residential, commercial and light industrial installations.
- Recommended for hot and cold water supply lines (up to 82 °C/179 °F).
- It has a higher resistance to high temperatures and corrosion than PVC.
- Its construction components contribute to keep drinking water in optimal conditions by preventing contamination.

PVC

Characteristics:

PVC stands for polyvinyl chloride, a thermoplastic material that remains stiff at room temperature but becomes softer and more malleable at high temperatures.

Suggested uses:

- It is recommended for use in sewage and wastewater piping, as well as for irrigation ducts.
- PVC is less expensive compared to galvanizing.
- Corrosion resistant.
- It shall be used only for cold water.

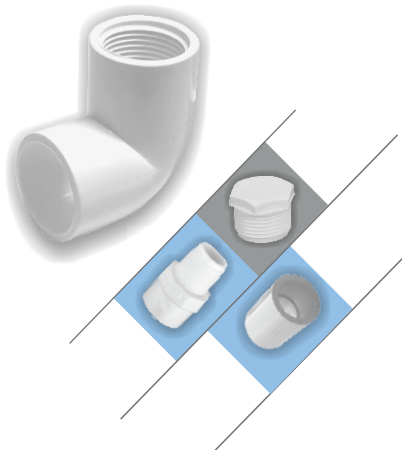

PPR

Characteristics:

Random polypropylene copolymer highly resistant to corrosion and pressure. Thanks to its non-toxic characteristics, PPR is an ideal material for a safe and hygienic domestic installation for drinking water. Pipes are connected by using a thermofusion welding machine, which creates an uninterrupted bond between the connections and the pipe itself, preventing leaks.

Suggested uses:

- Practical for water supply in residential buildings, hospitals, homes, hotels, among others.
- This material can be used to create piping networks for systems that use rainwater, so it is ideal for carrying any type of aggressive fluids.
- Resistant to corrosion and cold and hot water (up to 203 °F/95 °C).
- Thanks to thermofusion welding, pipes and connections create a continuous piping system that provides the highest level of safety in water supply installations.



Technical specifications

Material: CPVC

Differentiating attributes:

- Withstands impacts and high temperature (up to 179 °F/82 °C).
- Does not rust or corrode.
- Maximum resistance to deformation, chemical products and additives.

Meets the following Mexican standards:

- NMX-E-181-CNCP-2006.
- ASTM D 2846.
- Compatible with CPVC cements that meet standard ASTM F 493.



INNER MASTER

30-200	13 mm (½")	450	4500
30-300	19 mm (¾")	180	1800
30-400	25 mm (1")	90	900
30-100	32 mm (1¼")	1	520
30-310	38 mm (1½")	1	350
30-320	50 mm (2")	1	160



INNER MASTER

30-600	13 mm (½")	30	300
30-700	19 mm (¾")	20	200
30-900	25 mm (1")	10	110
30-931	32 mm (1¼")	1	72
30-932	38 mm (1½")	1	50
30-933	50 mm (2")	1	32



INNER MASTER

31-200	13 mm (½")	250	2500
31-300	19 mm (¾")	100	1000
31-400	25 mm (1")	50	500
31-500	32 mm (1¼")	1	270
31-600	38 mm (1½")	1	200
31-700	50 mm (2")	1	96



INNER MASTER

32-200	13 mm (½")	160	1600
32-300	19 mm (¾")	65	650
32-400	25 mm (1")	30	300
32-500	38 mm (1½")	1	170
32-600	32 mm (1¼")	1	100
32-700	50 mm (2")	1	48



INNER MASTER

33-200	13 mm (½")	170	1700
33-300	19 mm (¾")	75	750
33-500	25 mm (1")	35	350
33-600	32 mm (1¼")	1	200
33-400	38 mm (1½")	1	120
33-700	50 mm (2")	1	56



INNER MASTER

31-610	13 mm (½")	65	650
31-620	19 mm (¾")	40	400
31-630	25 mm (1")	27	270



INNER MASTER

43-200	13 mm (½")	45	450
--------	------------	----	-----



INNER MASTER

32-320	19 x 13 mm (¾" x ½")	85	850
--------	----------------------	----	-----

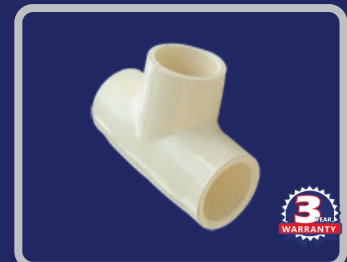

INNER MASTER

36-200	13 mm (½")	105	1050
36-300	19 mm (¾")	40	400
36-400	25 mm (1")	20	200
36-500	32 mm (1¼")	1	100
36-600	38 mm (1½")	1	66
36-700	50 mm (2")	1	40



INNER MASTER

36-332	19x19x13 mm ¾" x ¾" x ½"	55	550
36-333	25x25x19 mm 1" x 1" x ¾"	25	250
36-334	19x13x13 mm ¾" x ½" x ½"	55	550
36-335	19x13x19 mm ¾" x ½" x ¾"	45	450



INNER MASTER

37-200	13 mm (½")	170	1700
37-300	19 mm (¾")	95	950
37-400	25 mm (1")	50	500
37-500	32 mm (1¼")	1	280
37-600	38 mm (1½")	1	200
37-700	50 mm (2")	1	96



INNER MASTER

45-200	13 mm (½")	85	425
45-300	19 mm (¾")	52	260
45-400	25 mm (1")	28	140
45-500	32 mm (1¼")	1	60
45-600	38 mm (1½")	1	45
45-700	50 mm (2")	1	24



INNER MASTER

46-200	13 mm (½")	65	325
46-300	19 mm (¾")	40	200
46-400	25 mm (1")	22	110
46-500	32 mm (1¼")	1	60
46-600	38 mm (1½")	1	45
46-700	50 mm (2")	1	24



INNER MASTER

39-200	13 mm (½")	125	1250
39-300	19 mm (¾")	70	700
39-400	25 mm (1")	40	400
39-500	38 mm (1½")	1	160
39-600	50 mm (2")	1	72
39-700	32 mm (1¼")	1	220



INNER MASTER

40-320	19 x 13 mm ¾" x ½"	230	2300
40-400	50 x 13 mm 2" x ½"	1	200
40-500	25 x 13 mm 1" x ½"	105	1050
40-600	25 x 19 mm 1" x ¾"	105	1050
40-700	32 x 25 mm 1¼" x 1"	1	600
40-710	32 x 13 mm 1¼" x ½"	1	600
40-720	32 x 19 mm 1¼" x ¾"	1	600

INNER MASTER

40-800	38 x 13 mm 1½" x ½"	1	380
40-810	38 x 19 mm 1½" x ¾"	1	380
40-820	38 x 25 mm 1½" x 1"	1	380
40-830	38 x 32 mm 1½" x 1¼"	1	380
40-410	50 x 19 mm 2" x ¾"	1	200
40-420	50 x 25 mm 2" x 1"	1	200
40-430	50 x 32 mm 2" x 1¼"	1	200
40-440	50 x 38 mm 2" x 1½"	1	200



INNER MASTER

59-200	13 mm (½")	60	600
59-300	19 mm (¾")	35	350
59-400	25 mm (1")	20	200
59-500	32 mm (1¼")	1	120
59-600	38 mm (1½")	1	72
59-700	50 mm (2")	1	45

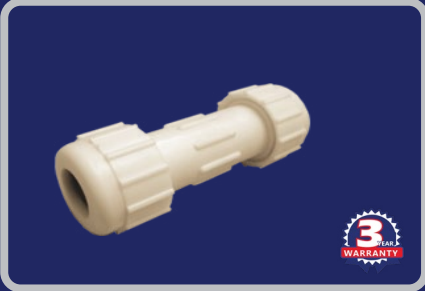

INNER MASTER

31-650	13 mm (1/2")	1	260
31-670	19 mm (3/4")	1	150
31-680	25 mm (1")	10	100

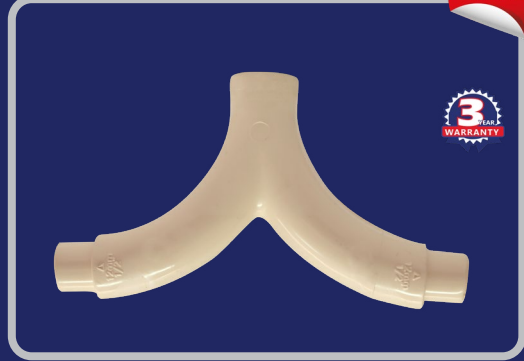

INNER MASTER

31-210	13 mm (1/2")	20	200
--------	--------------	----	-----



INNER MASTER

32-210	13 mm (1/2")	150	1500
--------	--------------	-----	------



INNER MASTER

43-210	13 mm (1/2")	40	200
--------	--------------	----	-----

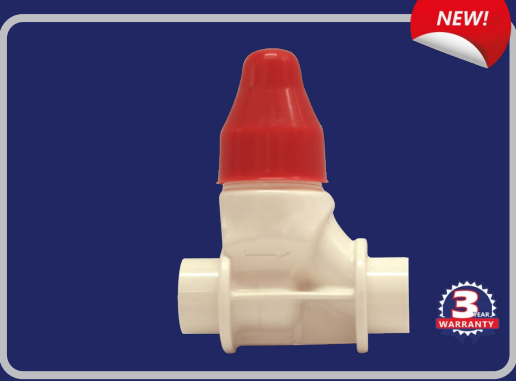

INNER MASTER

30-650	13 mm (1/2")	18	180
--------	--------------	----	-----

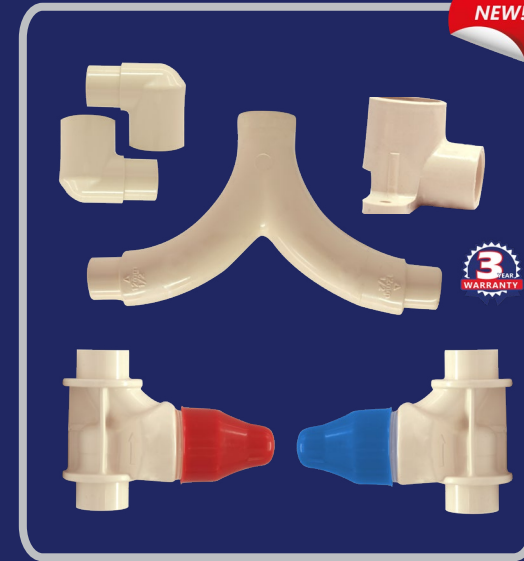

INNER MASTER

30-660	13 mm (1/2")	5	20
--------	--------------	---	----

Technical specifications

Material: Sanitary PVC, type 1, grade 1, 0.7 Mpa (7 kgf/cm²).

Differentiating attributes:

- High resistance.
- Easy installation.
- Does not rust or corrode.

Meets the following Mexican standards:

- NMX-E-199/2-SCFI-2003.
- ASTM D 2466.
- Compatible with PVC cements that meet standard NMX-E-030-SCFI-2002.



INNER MASTER

10-100	13 mm (½")	165	1650
10-200	19 mm (¾")	105	1050
10-300	25 mm (1")	65	650
10-400	32 mm (1¼")	35	350
10-500	38 mm (1½")	1	343
10-600	50 mm (2")	1	196



INNER MASTER

30-500	13 mm (½")	240	2400
11-200	19 mm (¾")	140	1400
11-300	25 mm (1")	75	750
11-400	32 mm (1¼")	1	420
11-500	38 mm (1½")	1	315
11-600	50 mm (2")	1	168



INNER MASTER

12-100	13 mm (½")	90	900
12-200	19 mm (¾")	60	600
12-300	25 mm (1")	35	350
12-400	32 mm (1¼")	1	295
12-500	38 mm (1½")	1	180
12-600	50 mm (2")	1	112



INNER MASTER

13-100	13 mm (½")	65	650
13-200	19 mm (¾")	35	350
13-300	25 mm (1")	22	220
13-400	32 mm (1¼")	1	150
13-500	38 mm (1½")	1	95
13-600	50 mm (2")	1	58



INNER MASTER

14-100	13 mm (½")	70	700
14-200	19 mm (¾")	45	450
14-300	25 mm (1")	25	250
14-400	32 mm (1¼")	1	180
14-500	38 mm (1½")	1	110
14-600	50 mm (2")	1	66



INNER MASTER

15-100	13 mm (½")	40	440
15-200	19 mm (¾")	25	250
15-300	25 mm (1")	15	135
15-400	32 mm (1¼")	1	100
15-500	38 mm (1½")	1	66
15-600	50 mm (2")	1	40



INNER MASTER

13-210	19 x 13 mm ¾" x ½"	45	450
--------	-----------------------	----	-----



INNER MASTER

10-210	13 mm (½")	195	1950
10-220	19 mm (¾")	110	1100
10-230	25 mm (1")	75	750



3 YEARS WARRANTY

INNER MASTER

16-100	13 mm (1/2")	100	1000
16-200	19 mm (3/4")	65	650
16-300	25 mm (1")	40	360
16-400	32 mm (1 1/4")	1	435
16-500	38 mm (1 1/2")	1	270
16-600	50 mm (2")	1	168



3 YEARS WARRANTY

INNER MASTER

17-100	13 mm (1/2")	75	750
17-200	19 mm (3/4")	55	550
17-300	25 mm (1")	30	300
17-400	32 mm (1 1/4")	1	216
17-500	38 mm (1 1/2")	1	160
17-600	50 mm (2")	1	112

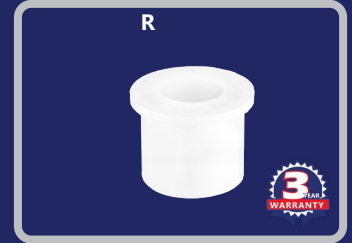

3 YEARS WARRANTY

INNER MASTER

18-100	19 x 13 mm 3/4" x 1/2"	120	1200
18-200	25 x 13 mm 1" x 1/2"	70	700
18-300	25 x 19 mm 1" x 3/4"	70	700
18-400	32 x 25 mm 1 1/4" x 1"	1	450
18-500	38 x 32 mm 1 1/2" x 1 1/4"	1	300
18-600	50 x 38 mm 2" x 1 1/2"	1	228
18-700	38 x 25 mm 1 1/2" x 1"	1	300
18-800	50 x 25 mm 2" x 1"	1	180



3 YEARS WARRANTY

INNER MASTER

19-100	13 mm (1/2")	30	300
19-200	19 mm (3/4")	20	200
19-300	25 mm (1")	15	120
19-400	32 mm (1 1/4")	1	96
19-500	38 mm (1 1/2")	1	48
19-600	50 mm (2")	1	36



3 YEARS WARRANTY

INNER MASTER

20-100	13 mm (1/2")	1	180
20-200	19 mm (3/4")	1	162
20-300	25 mm (1")	1	105
20-400	32 mm (1 1/4")	1	70
20-500	38 mm (1 1/2")	1	48
20-600	50 mm (2")	1	40



3 YEARS WARRANTY

INNER MASTER

21-100	13 mm (1/2")	1	226
21-200	19 mm (3/4")	1	150
21-300	25 mm (1")	1	90
21-400	32 mm (1 1/4")	1	52
21-500	38 mm (1 1/2")	1	40
21-600	50 mm (2")	1	24

Threaded PVC ball valve

24-100	13 mm (1/2")	1	220
24-200	19 mm (3/4")	1	150
24-300	25 mm (1")	1	90

INNER MASTER

23-700	38x32 mm (1 1/2" x 1 1/4")	1	170
23-800	50 x 32 mm (2" x 1 1/4")	1	168
23-900	50 x 38 mm (2" x 1 1/2")	1	154



3 YEARS WARRANTY

INNER MASTER

22-100	13 mm (1/2")	60	600
22-200	19 mm (3/4")	40	400
22-300	25 mm (1")	20	200
22-400	32 mm (1 1/4")	1	120
22-500	38 mm (1 1/2")	1	93
22-600	50 mm (2")	1	60



3 YEARS WARRANTY

INNER MASTER

23-100	19 x 13 mm (3/4" x 1/2")	65	650
23-200	25 x 13 mm (1" x 1/2")	48	480
23-300	25 x 19 mm (1" x 3/4")	42	420
23-400	32 x 19 mm (1 1/4" x 3/4")	1	399
23-500	32 x 25 mm (1 1/4" x 1")	1	360
23-600	38 x 25 mm (1 1/2" x 1")	1	264

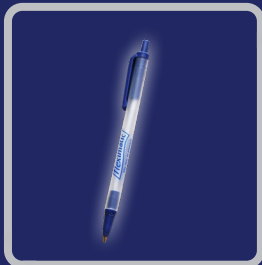

PPR-01-03

BIC ballpen



PIM-06-01

Mini-catalogue



PIM-05-01

Catalogue



PPR-06-03 Eco-friendly bag (red)

PPR-06-04 Eco-friendly bag (blue)



PLN-01-01

Advertising canvas
44" x 28" (112 x 72 cm)



PPT-01-03

Thermoformed poster



PPT-02-01

Poster



6011

Display 6011 23.6" x 23.6"
(60 x 60 cm)



6000

Display 6000 47" x 23.6"
(120 x 60 cm)



6019

Faucet display rack 14" x 17.7"
(36 x 45 cm)



6029

Easy-install drain display
6.3" x 6.3" x 8.7" (16 cm x 16 cm
x 22 cm)



PPL-02-01 Polo shirt S (white)



PPL-02-02 Polo shirt M (white)



PPL-02-03 Polo shirt L (white)

PPL-02-04 Polo shirt XL (white)



PPL-02-05 Polo shirt S (blue)

PPL-02-06 Polo shirt M (blue)

PPL-02-07 Polo shirt L (blue)

PPL-02-08 Polo shirt XL (blue)



PPL-02-09 Polo shirt S (red)

PPL-02-10 Polo shirt M (red)

PPL-02-11 Polo shirt L (red)

PPL-02-12 Polo shirt XL (red)



PPL-02-17 Round neck T-shirt S

PPL-02-18 Round neck T-shirt M

PPL-02-19 Round neck T-shirt L

PPL-02-20 Round neck T-shirt XL

Coming soon to the Fleximatic family

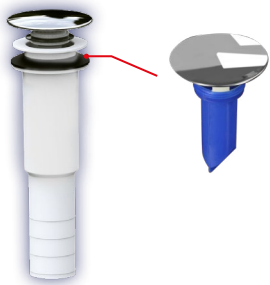

Code 2212B

Zero Leakage tailpiece w/ anti-odor check valve for bathroom sink.

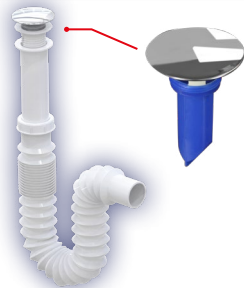

Code 2218B

Flexible P-trap w/ anti-odor check valve for bathroom sink.

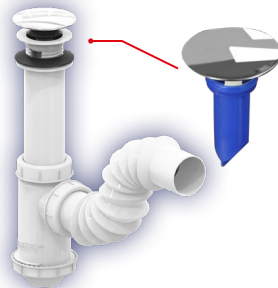

Code 2235B

Flexible trap w/ small bottle and anti-odor check valve for bathroom sink.



Code 2248A

Universal square push drain with anti-odor check valve.



Code 2249A

Universal push drain with anti-odor check valve.



Code 2252

Anti-odor check valve for push drain.



Code 2493

1/2" outdoor ball valve 1/4 turn with POM insert.



Code 2304

Round push drain spare cover.

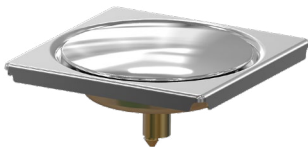

Code 2305

Square push drain spare cover.



Code 2031

Compact Maxtor Washboard



Code 2032

Washboard (without sink)

First look at our new line of **bathroom accessories!**



Code 2803

Shower organizer.



Code 2804

Towel bar with suction cups



Code 2800

Soap dish with suction cup for bathroom.

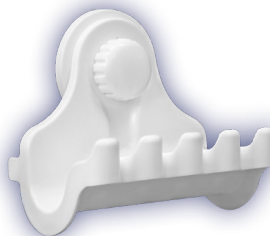

Code 2801

Toothbrush holder with suction cup.



Code 2802

Hook with suction cup.

Customer Service: **800 112 0292**
Switchboard: **800 08 35394**
ext. 235

SERVICE POLICIES

Warranty

All Fleximatic products come with a full warranty against manufacturing defects that may be validated through your representative or by reaching our customer service department.

Our products must be installed in accordance with the instructions printed on the back of our packages. For this reason, it is imperative that the installer reads, understands and follows the instructions correctly. The warranty will be considered void if any component is installed in a manner inconsistent with our installation guides.

Inquiries and returns

For your convenience, our customer service department is available for any inquiry by calling 800-112-0292 or by sending an e-mail to atencionaclientes@fleximatic.com.mx or fleximatic@fleximatic.com.mx.

Orders

All orders and customers are important for us at Fleximatic. To provide you with a better service, our sales policy requires a minimum net purchase of USD \$ 6,000.00. Any orders for smaller amounts will be forwarded to your chosen nearest distributor.

Fleximatic covers freight costs for up to 5% of the total order; in case of exceeding this amount, the difference shall be borne by the customer and/or the order amount must be increased to meet said percentage.

Dial our toll free 800 lines or send an e-mail to: exports@fleximatic.com.mx

Payment terms

When starting a commercial relationship with Fleximatic, the payment conditions for the first three purchases are strictly up-front payment via bank transfer to our account before the order ships.



Quality & Trust

Ph. 33 3540 1050
800 08 FLEXI
35394

Fleximatic S.A. de C.V.

Camino Real de Colima No.901-14
C.P. 45645 Tlajomulco de Zúñiga,
Jalisco, Mexico.

www.fleximatic.com.mx

fleximatic@fleximatic.com.mx

